

**Tutorial Notes**

**An Introduction to  
Information Visualization  
Techniques  
for Exploring Large Databases**

*Daniel A. Keim*

*Institute for Computer Science*

*University of Halle*

A pdf version of the tutorial notes is available under  
“<http://www.informatik.uni-halle.de/~keim>”

# Overview

1. Introduction .....	2
2. Data Preprocessing Techniques.....	9
3. Visual Data Exploration Techniques .....	11
• Geometric Techniques .....	11
• Icon-based Techniques .....	21
• Pixel-Oriented Techniques .....	31
• Hierarchical Techniques .....	51
• Graph-based Techniques .....	60
• Hybrid Techniques .....	72
4. Distortion Techniques .....	73
5. Dynamic / Interaction Techniques .....	81
6. Comparison of the Techniques .....	96
7. Database Exploration and Visualization Systems .....	98
8. Summary and Conclusion .....	103
Bibliography .....	105

The screens dumps of systems other than the VisDB System are copyright  
of the respective authors and are taken from the cited publications.

# Introduction

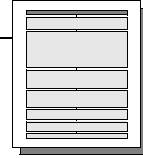

## Goals of Visualization Techniques

- Explorative Analysis**
  - starting point: data without hypotheses about the data
  - process: interactive, usually undirected search for structures, trends, etc.
  - result: visualization of the data, which provides hypotheses about the data
- Confirmative Analysis**
  - starting point: hypotheses about the data
  - process: goal-oriented examination of the hypotheses
  - result: visualization of the data, which allows the confirmation or rejection of the hypotheses
- Presentation**
  - starting point: facts to be presented are fixed a priori
  - process: choice of an appropriate presentation technique
  - result: high-quality visualization of the data presenting the facts

# Introduction

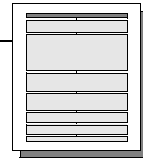

## Data Exploration

### Definition

Data Exploration is the process of searching and analyzing databases to find implicit but potentially useful information.

### *more formally:*

Data Exploration is the process of finding a

- subset  $D'$  of the database  $D$  and
- hypotheses  $H_u(D', C)$

that a *user*  $U$  considers *useful* in an *application context*  $C$ .

# Introduction

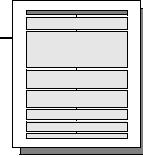

## *Comparison of the Abilities of Humans and Computers*

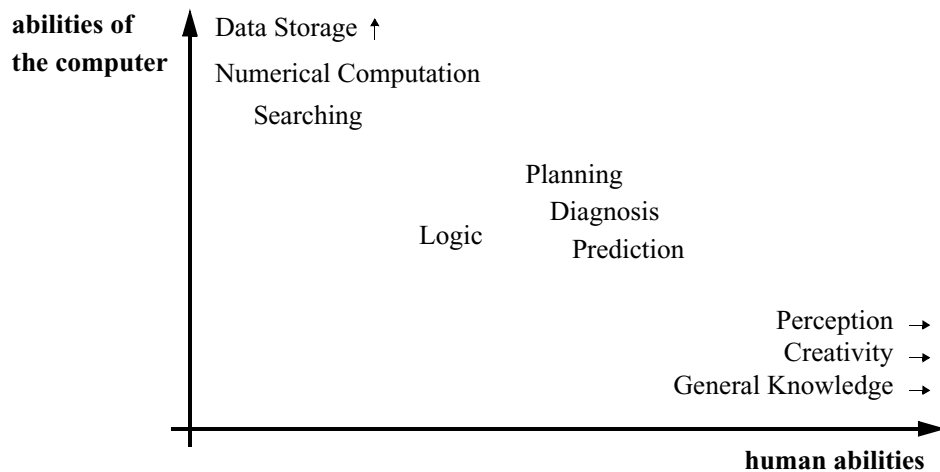

# Introduction

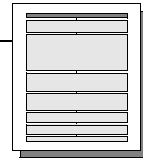

## **Historical Overview of Exploratory Data Visualization Techniques** (cf. [WB 95])

- pioneering work of Tufte [Tuf 83, Tuf 90] and Bertin [Ber 81] focuses on
  - ⇒ visualization of data with inherent 2D-/3D-semantics
  - ⇒ general rules for layout, color composition, attribute mapping, etc.
- development of visualization techniques for different types of data with an underlying physical model
  - ⇒ geographic data, CAD data, flow data, image data, voxel data, etc.
- development of visualization techniques for arbitrary multidimensional data (without an underlying physical model)
  - ⇒ applicable to databases and other information resources



# Introduction

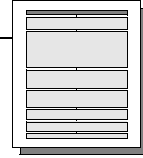

## Dimensions of Exploratory Data Visualizations

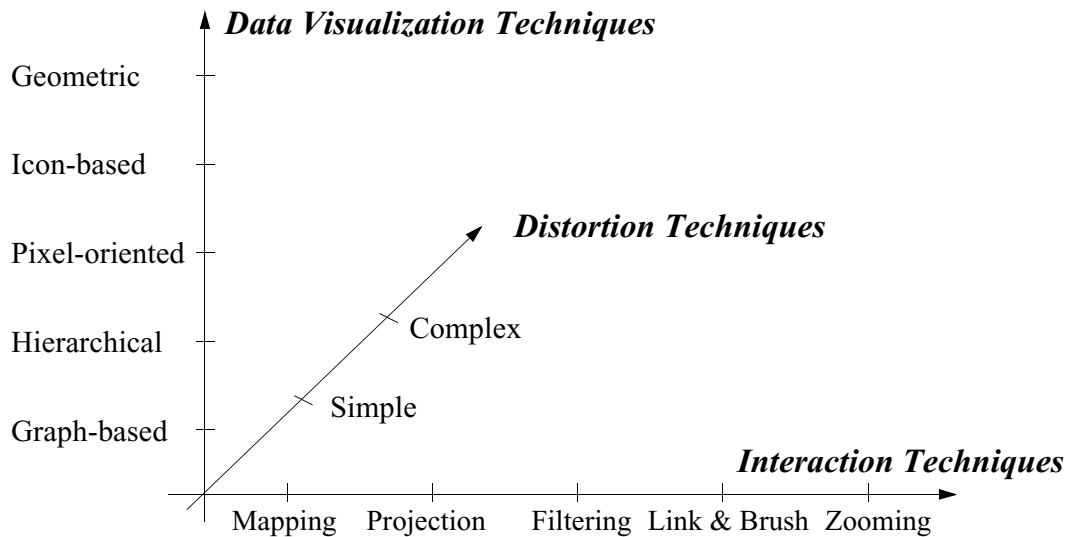

# Introduction

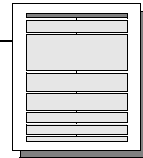

## Classification of Data Visualization Techniques

- Geometric Techniques: Scatterplots, Landscapes, Projection Pursuit, Prosecution Views, Hyperslice, *Parallel Coordinates*, ...
- Icon-based Techniques: Chernoff Faces, *Stick Figures*, Shape-Coding, Color Icons, TileBars, ...
- Pixel-oriented Techniques: *Recursive Pattern Technique*, *Circle Segments Technique*, *Spiral- & Axes-Techniques*, ...
- Hierarchical Techniques: Dimensional Stacking, Worlds-within-Worlds, *Treemap*, Cone Trees, InfoCube, ...
- Graph-Based Techniques: Basic Graphs (Straight-Line, Polyline, Curved-Line, ..) Specific Graphs (e.g., DAG, Symmetric, Cluster, ...) Systems (e.g., Tom Sawyer, Hy<sup>+</sup>, *SeeNet*, *Narcissus*, ...)
- Hybrid Techniques: arbitrary combinations from above

# Introduction

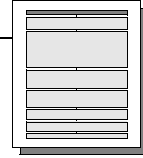

## Distortion and Dynamic / Interaction Techniques

### □ Distortion Techniques

- Simple Distortion (e.g., *Perspective Wall*, Bifocal Lenses, *TableLens*, *Graphical Fisheye Views*, ...)
- Complex Distortion (e.g., Hyperbolic Repr., *Hyperbox*, ...)

### □ Dynamic / Interaction Techniques

- Data-to-Visualization Mapping (e.g., AutoVisual, S Plus, *XGobi*, *IVEE*, ...)
- Projections (e.g., GrandTour, S Plus, *XGobi*, ...)
- Filtering (Selection, Querying) (e.g., *MagicLens*, *Filter/Flow Queries*, *InfoCrystal*, ...)
- Linking & Brushing (e.g., *Xmdv-Tool*, *XGobi*, DataDesk, ...)
- Zooming (e.g., PAD++, *IVEE*, DataSpace, ...)
- Detail on Demand (e.g., *IVEE*, TableLens, *MagicLens*, *VisDB*, ...)

# Data Preprocessing Techniques

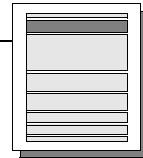

### □ Techniques for Dimension Reduction

(Set of d-dim Data Items -> Set of k-dim. Data Items;  $k \ll d$ )

- Principal Component Analysis [DE 82]  
Determines a minimal set of principal components (linear combinations of the original dimensions) which explain the main variations of the data.
- Factor Analysis [Har 67]  
Determines a set of unobservable common factors which explain the main variations of the data. The original dimensions are linear combinations of the common factors.
- Multidimensional Scaling [SRN 72]  
Uses the similarity (or dissimilarity) matrix of the data as defining coordinate axes in multidimensional space. The Euclidean distance in that space is a measure of the similarity of the data items.
- Fastmap [FL 95]  
Fastmap also operates on a given similarity matrix and iteratively reduces the number of dimensions while preserving the distances as much as possible.

# Data Preprocessing Techniques

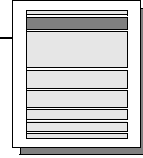

## Subsetting Techniques

(Set of Data Items -> Subset of Data Items)

- Sampling (determines a representative subset of the database)
- Querying (determines a certain, usually a-priori fixed subset of the database)

## Segmentation Techniques

(Set of Data Items -> Set of (Set of Data Items))

- Segmentation based upon attribute values or attribute ranges

## Aggregation Techniques

(Set of Data Items -> Set of Aggregate Values)

- Aggregation (sum, count, min, max, ...) based upon
  - attribute values
  - topological properties, etc.
- Visualizations of Aggregations:
  - Histograms
  - Pie Charts, Bar Charts, Line Graphs, etc.

# Geometric Techniques

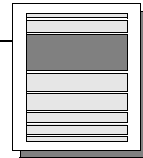

**Basic Idea:** Visualization of geometric transformations and projections of the data.

## Overview

- Scatterplot-Matrices [And 72, Cle 93]
- Landscapes [Wis 95]
- Projection Pursuit Techniques [Hub 85]  
(⇔ techniques for finding meaningful projections of multidimensional data)
- Prosection Views [FB 94, STDS 95]
- Hyperslice [WL 93]
- Parallel Coordinates [Ins 85, ID 90]

# Geometric Techniques

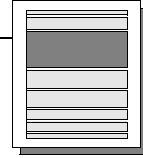

## Scatterplot-Matrices [Cle 93]

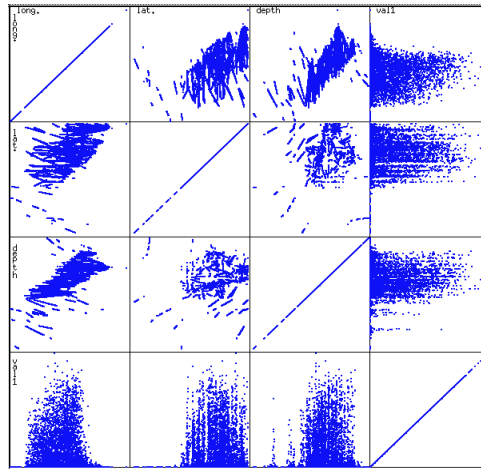

used by permission of M. Ward, Worcester Polytechnic Institute

⇒ matrix of scatterplots (x-y-diagrams) of the k-dim. data [total of  $(k^2/2 - k)$  scatterplots]

# Geometric Techniques

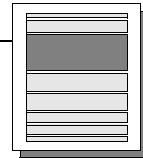

## Landscapes [Wis 95]

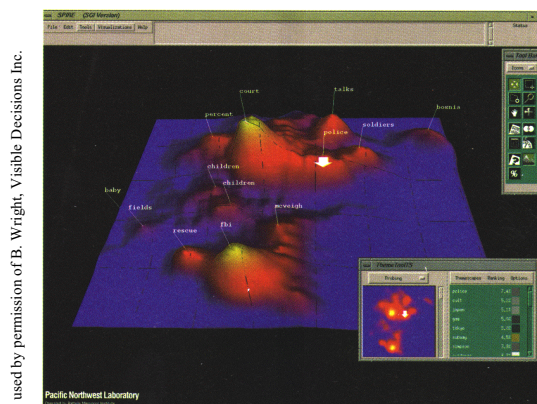

used by permission of B. Wright, Visible Decisions Inc.  
Pacific Northwest Laboratory

news articles  
visualized as  
a landscape

- ⇒ visualization of the data as perspective landscape
- ⇒ the data needs to be transformed into a (possibly artificial) 2D spatial representation which preserves the characteristics of the data

# Geometric Techniques

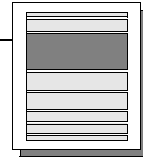

## Prosection Views [FB 94, STDS 95]

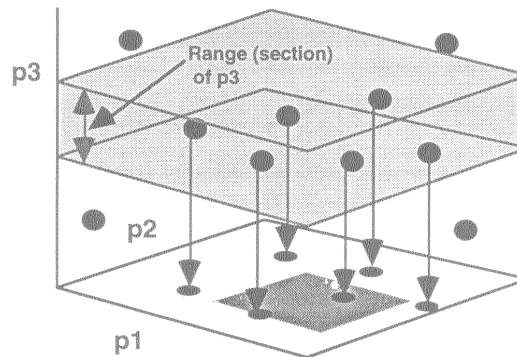

used by permission of R. Spence, Imperial College London

**schematic representation**

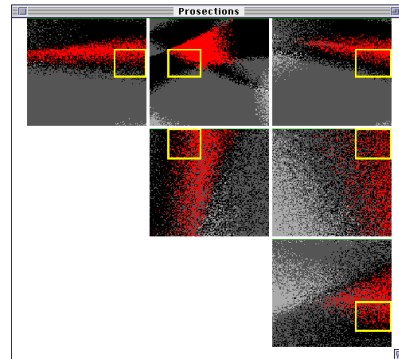

used by permission of R. Spence, Imperial College London

**example**

⇒ matrix of all orthogonal projections where the result of the selected multidimensional range is colored differently (combination of selections and projections)

# Geometric Techniques

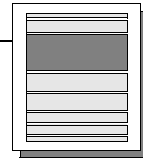

## Hyperslice [WL 93]

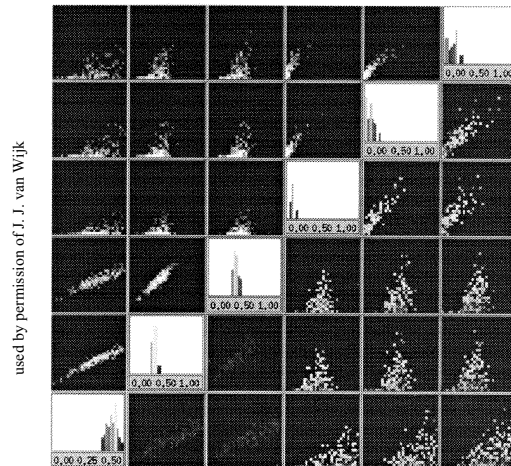

⇒ matrix of  $k^2$  slices through the  $k$ -dim. data (the slices are determined interactively)

# Geometric Techniques

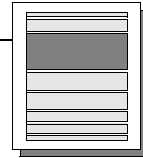

## Parallel Coordinates [Ins 85, ID 90]

- ⇒  $n$  equidistant axes which are parallel to one of the screen axes and correspond to the attributes
- ⇒ the axes are scaled to the [minimum, maximum] - range of the corresponding attribute
- ⇒ every data item corresponds to a polygonal line which intersects each of the axes at the point which corresponds to the value for the attribute

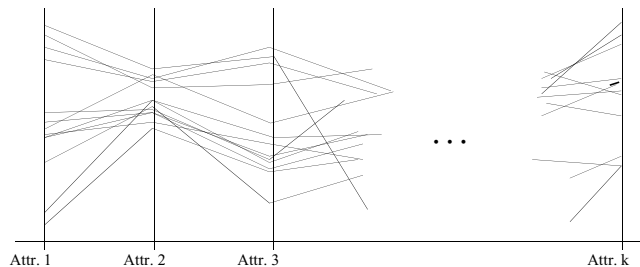

# Geometric Techniques

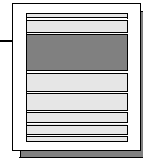

## Parallel Coordinates (cont'd)

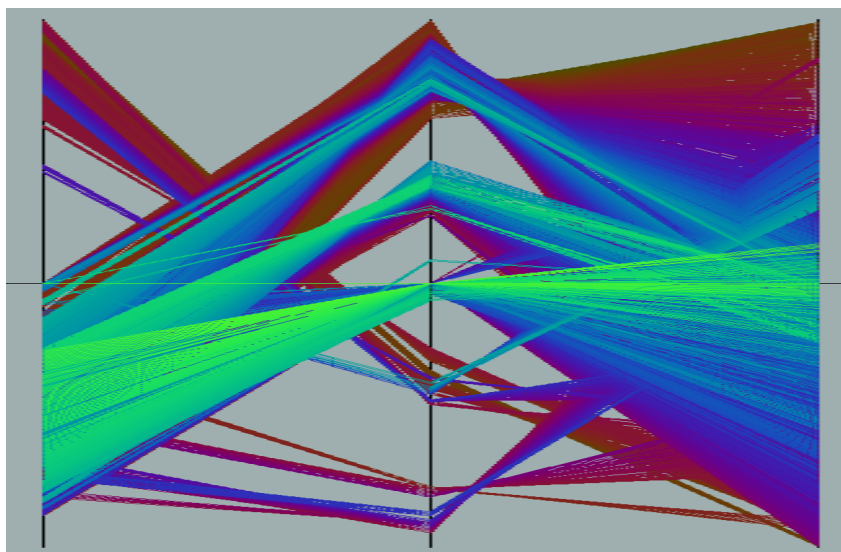

# Geometric Techniques

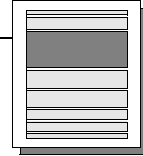

## Parallel Coordinates (cont'd)

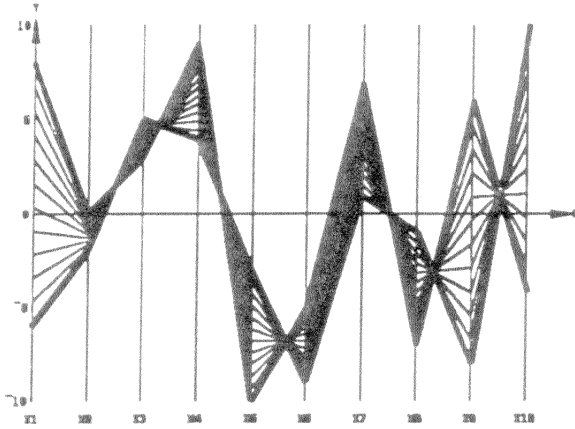

used by permission of A. Inselberg, Tel Aviv University, Israel

points on a line in 10-dim. space

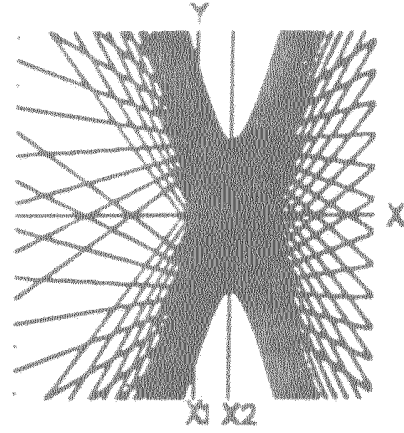

used by permission of A. Inselberg

points on a circle in 2-dim. space

# Geometric Techniques

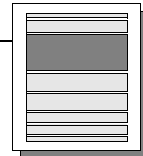

## Parallel Coordinates (cont'd)

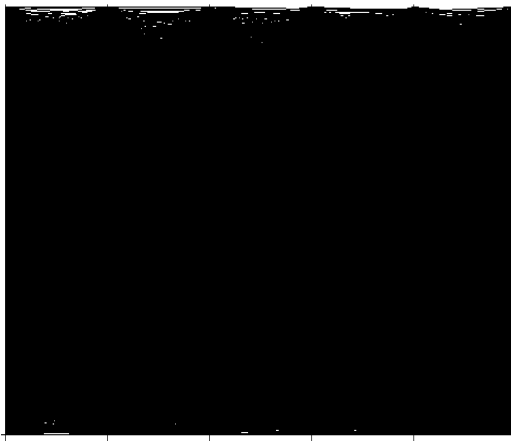

15,000 data items with noise

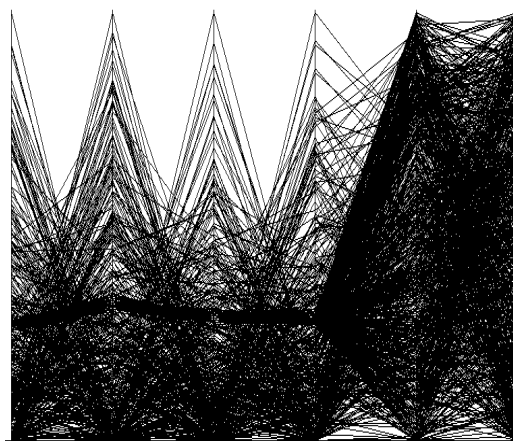

5% of the data (750 data items)



# Geometric Techniques

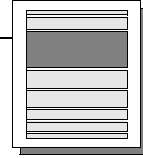

## Parallel Coordinates (cont'd)

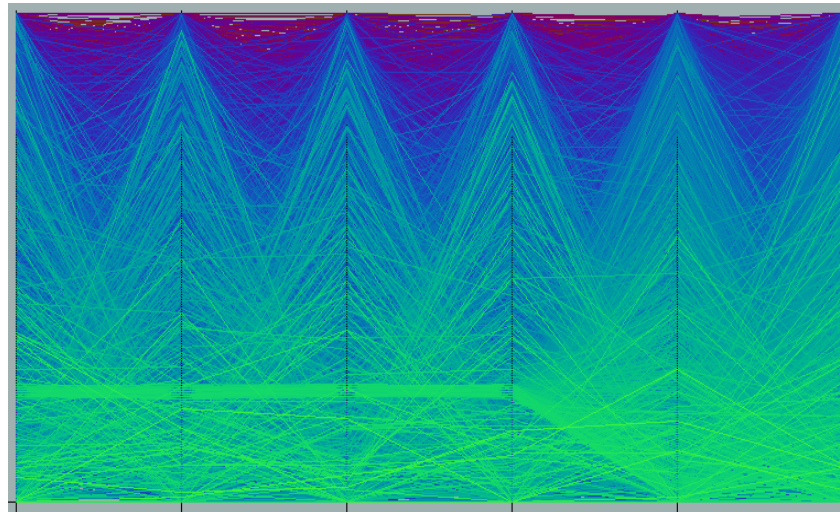

15.000 data items with a query-dependent coloring

# Icon-based Techniques

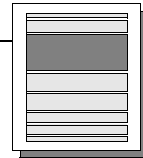

**Basic Idea:** Visualization of the data values as features of icons.

## Overview

- Chernoff-Faces [Che 73, Tuf 83]
- Stick Figures [Pic 70, PG 88]
- Shape Coding [Bed 90]
- Color Icons [Lev 91, KK 94]
- TileBars [Hea 95]  
(↔ use of small icons representing the relevance feature vectors in document retrieval)



# Icon-based Techniques

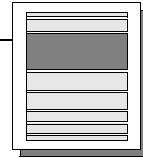

## Chernoff-Faces [Che 73, Tuf 83]

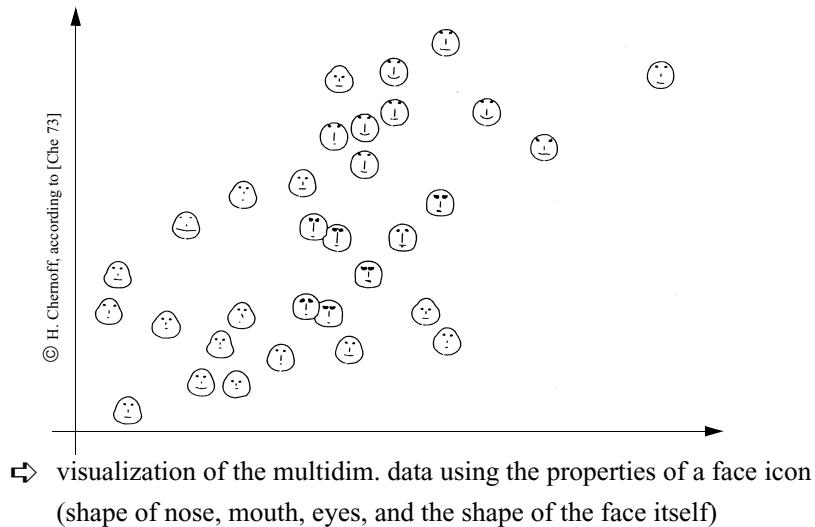

# Icon-based Techniques

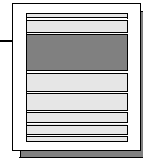

## Stick Figures [Pic 70, PG 88]

- ⇒ visualization of the multidimensional data using stick figure icons
- ⇒ two attributes of the data are mapped to the display axes and the remaining attributes are mapped to the angle and/or length of the limbs
- ⇒ texture patterns in the visualization show certain data characteristics

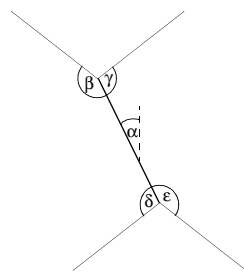

Stick Figure Icon

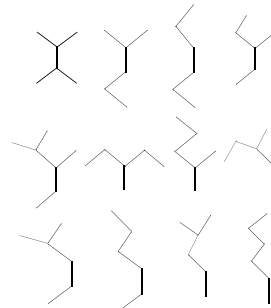

A Family of Stick Figures

# Icon-based Techniques

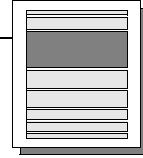

## Stick Figures (cont'd)

used by permission of G. Grinstein, University of Massachusetts at Lowell

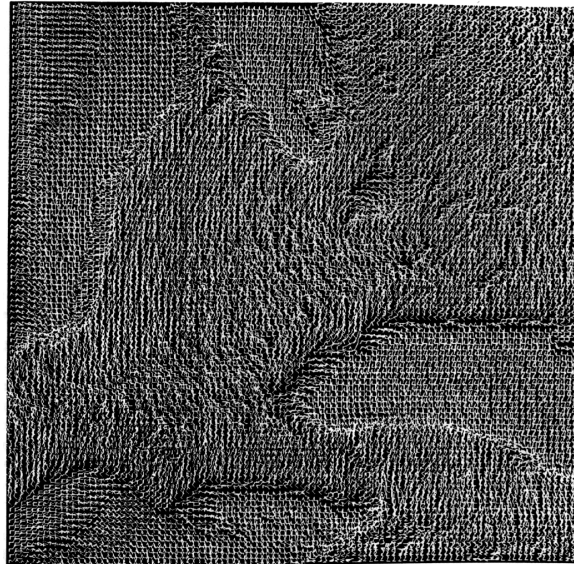

5-dim. image data from the great lake region

# Icon-based Techniques

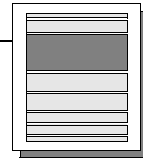

## Stick Figures (cont'd)

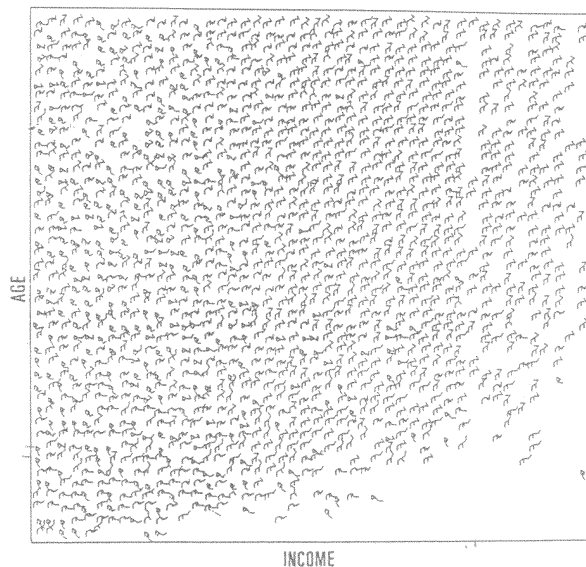

used by permission of G. Grinstein, University of Massachusetts at Lowell

census data showing age, income, sex, education, etc.

# Icon-based Techniques

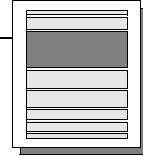

## Stick Figures (cont'd)

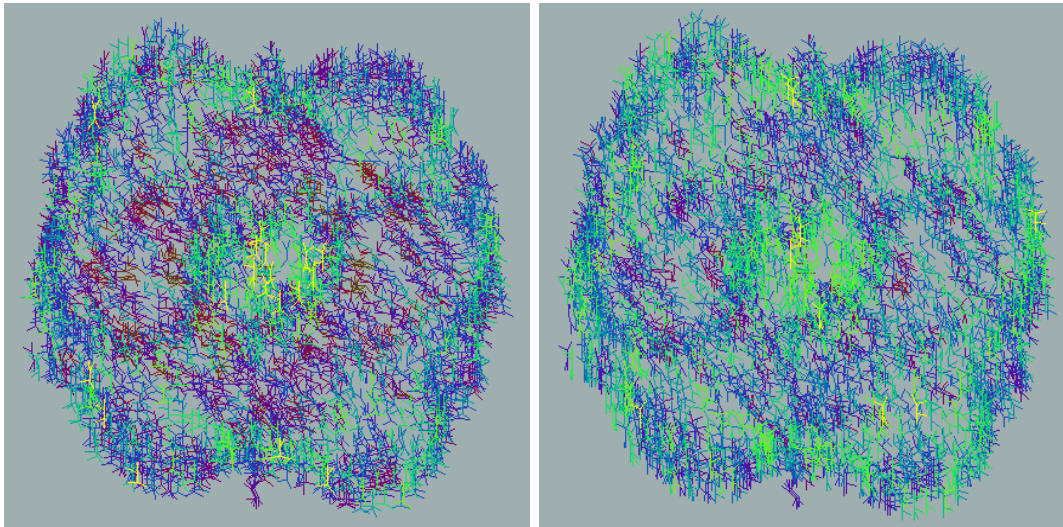

properties of the triangulation of molecule data

# Icon-based Techniques

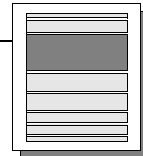

## Shape Coding [Bed 90]

- ⇒ the data are visualized using small arrays of fields
- ⇒ each field represents one attribute value
- ⇒ arrangement of attribute fields (e.g., 12-dimensional data):

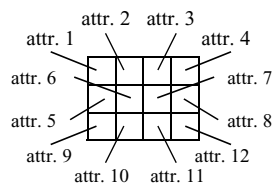

- ⇒ arrays are arranged line-by-line according to a given sorting (e.g., the time attribute for time-series data)

# Icon-based Techniques

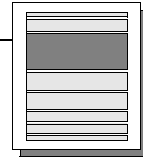

## Shape Coding (cont'd)

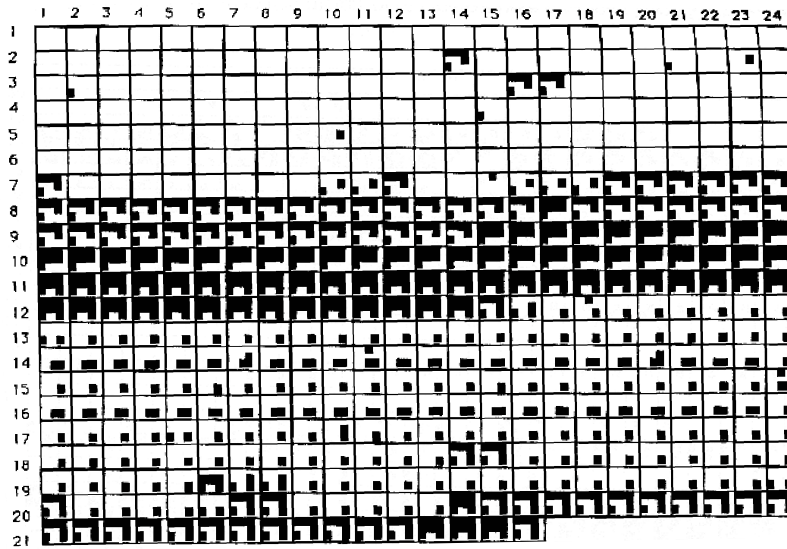

time series of  
NASA earth  
observation data

used by permission of J. Beddow

# Icon-based Techniques

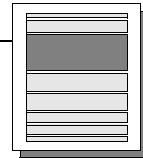

## Color Icons [Lev 91, KK 94]

- ⇒ visualization of the data using color icons
- ⇒ color icons are arrays of color fields representing the attribute values
- ⇒ arrangement is query-dependent (e.g., spiral)

schematic  
representation  
of 6-dim. data

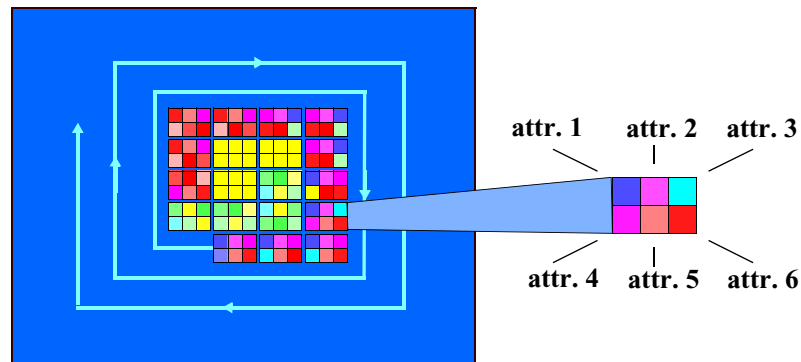

# Icon-based Techniques

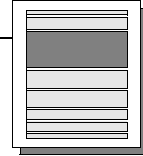

## Color Icons (cont'd)

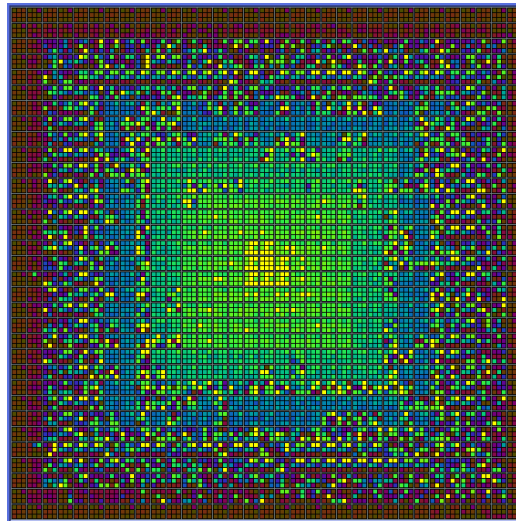

random data containing several clusters

# Pixel-oriented Techniques

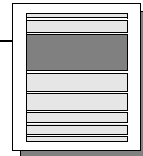

## Basic Idea

- each attribute value is represented by one colored pixel (⇒ the value ranges of the attributes are mapped to a fixed colormap)
- the attribute values for each attribute are presented in separate subwindows
- example:

visualization of six-dim. data

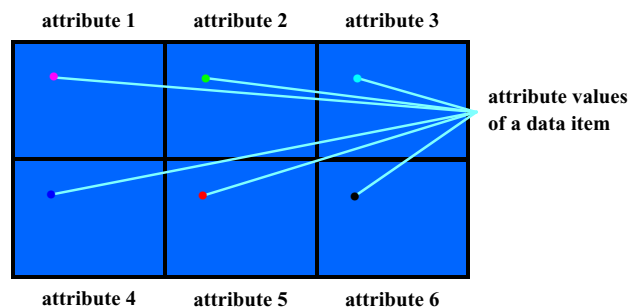

# Pixel-oriented Techniques

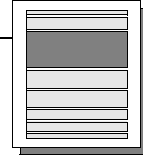

## Overview [Kei 96]

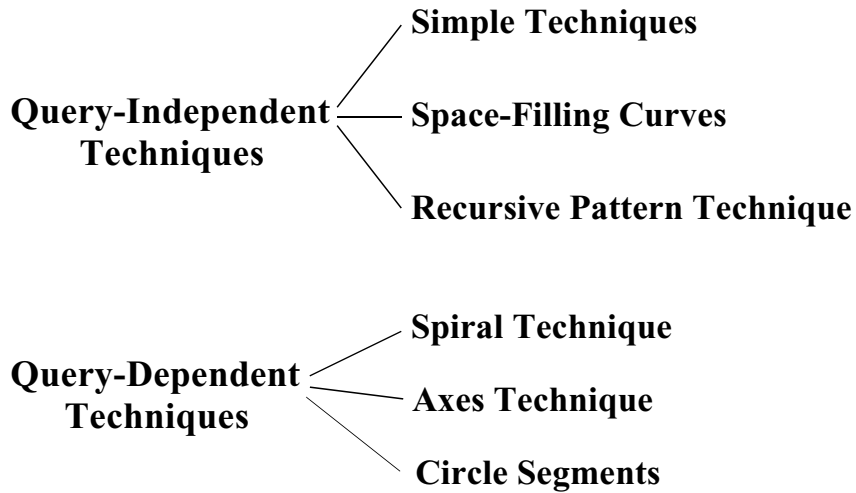

# Pixel-oriented Techniques

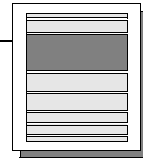

## Query-Independent Techniques: Space-Filling Curve Arrangements

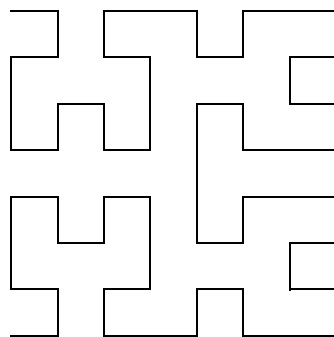

**Peano-Hilbert**

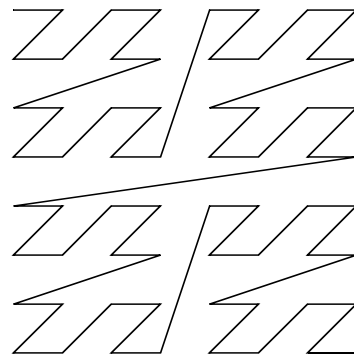

**Morton (Z-Curve)**

## Pixel-oriented Techniques

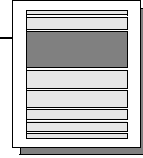

### Space-Filling Curve Arrangements

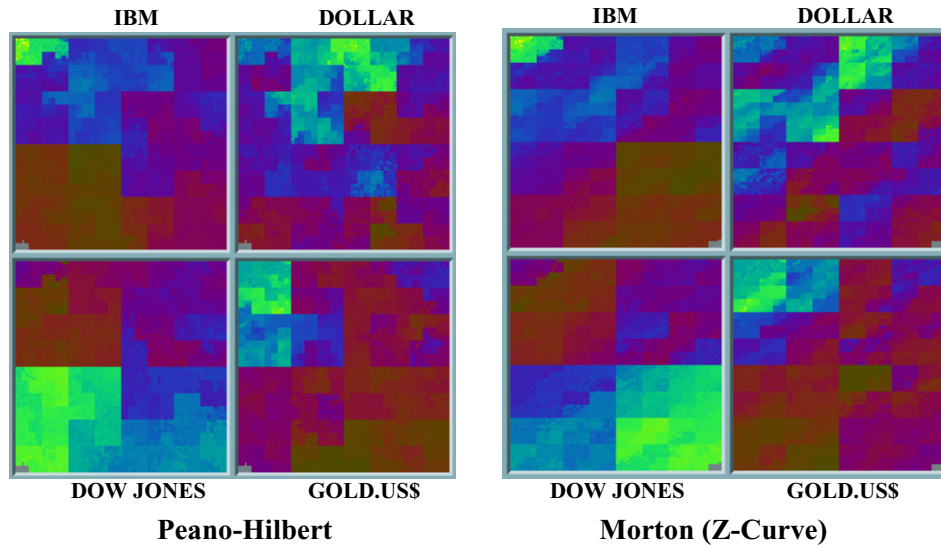

## Pixel-oriented Techniques

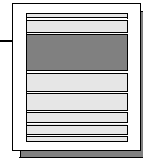

### Query-Independent Techniques: Recursive Pattern Technique [KKA 95]

- recursive generalization of iterated line- and column-based arrangements
- the user may specify the height  $h_i$  and width  $w_i$  for each recursion level
- on recursion level  $i$ ,  $w_i$  patterns of recursion level  $(i-1)$  are drawn in left-right direction and this is repeated  $h_i$  times in top-down direction
- ⇒ the pattern on recursion level  $i$  consists of  $w_i \times h_i$  patterns of recursion level  $(i-1)$



# Pixel-oriented Techniques

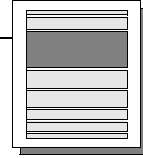

## Recursive Pattern: Possible Arrangements

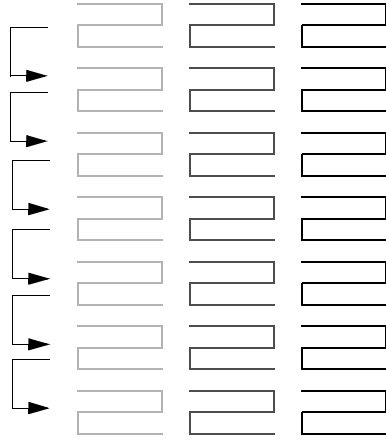

line-by-line loop

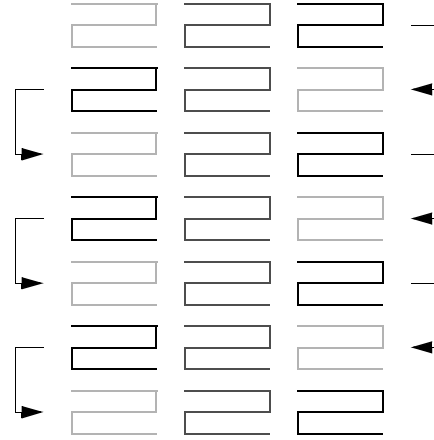

back-and-forth loop

# Pixel-oriented Techniques

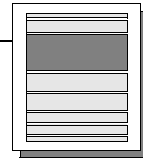

## Recursive Pattern: Example of a Structured Arrangement

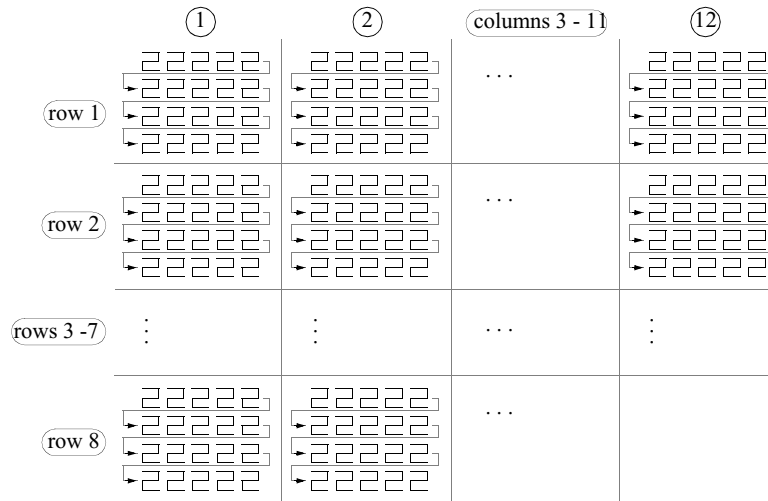

$(w_1, h_1) = (3, 3)$ ,  $(w_2, h_2) = (5, 1)$ ,  $(w_3, h_3) = (1, 4)$ ,  $(w_4, h_4) = (12, 1)$ , and  $(w_5, h_5) = (1, 8)$



# Pixel-oriented Techniques

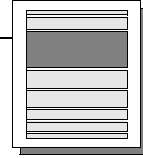

## Recursive Pattern: Example of Financial Data

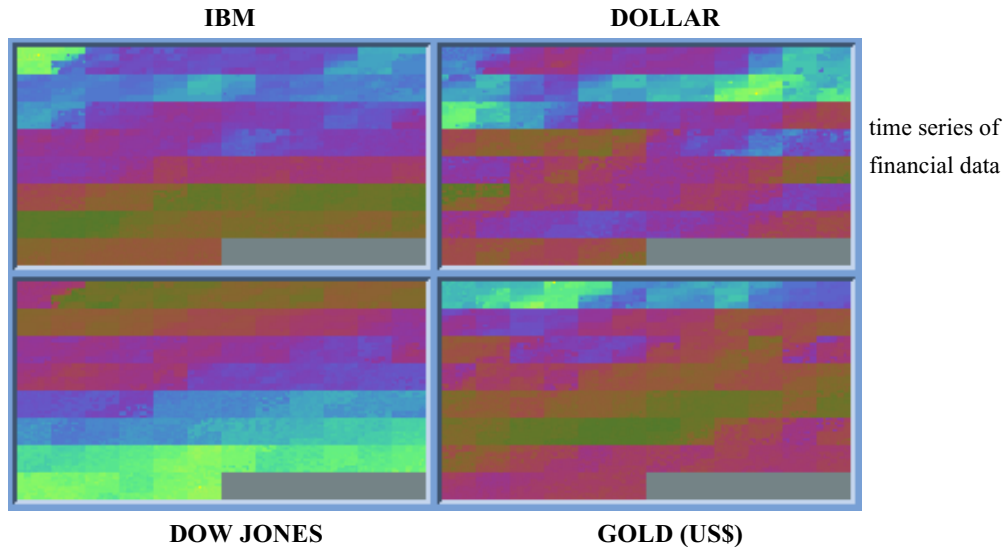

# Pixel-oriented Techniques

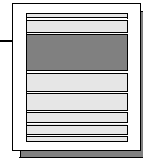

## Recursive Pattern: FAZ-Index (Jan. '74 - Apr. '95)

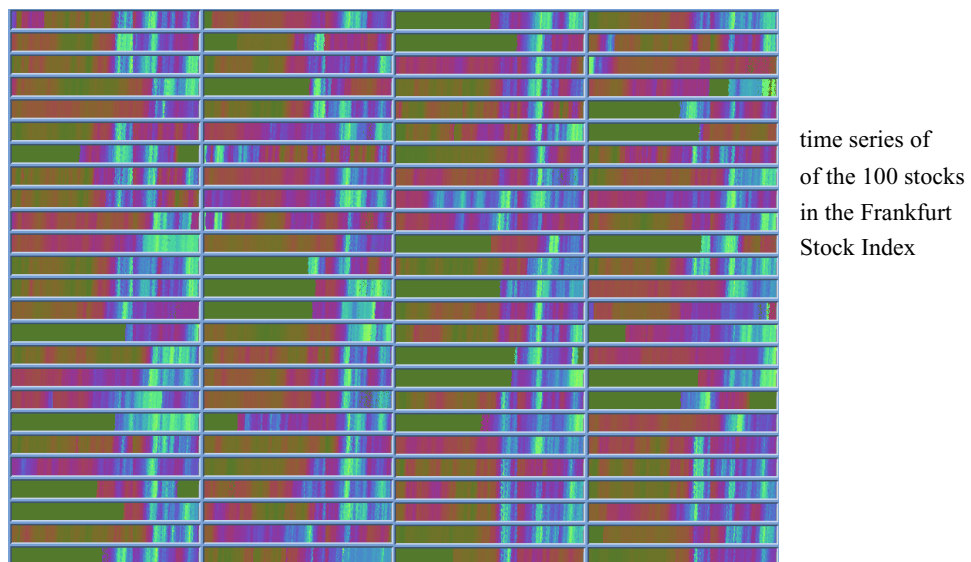

# Pixel-oriented Techniques

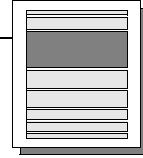

## Query-Dependent Techniques: Basic Idea

- data items ( $a_1, a_2, \dots, a_m$ ) & query ( $q_1, q_2, \dots, q_m$ )  
     $\Leftrightarrow$  distances ( $d_1, d_2, \dots, d_m$ )
- extend distances by overall distance ( $d_{m+1}$ )
- determine data items with lowest overall distances
- map distances to color (for each attribute)
- visualize each distance value  $d_i$  by one colored pixel

# Pixel-oriented Techniques

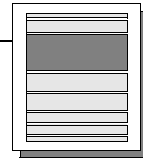

## Calculating the Visualizations

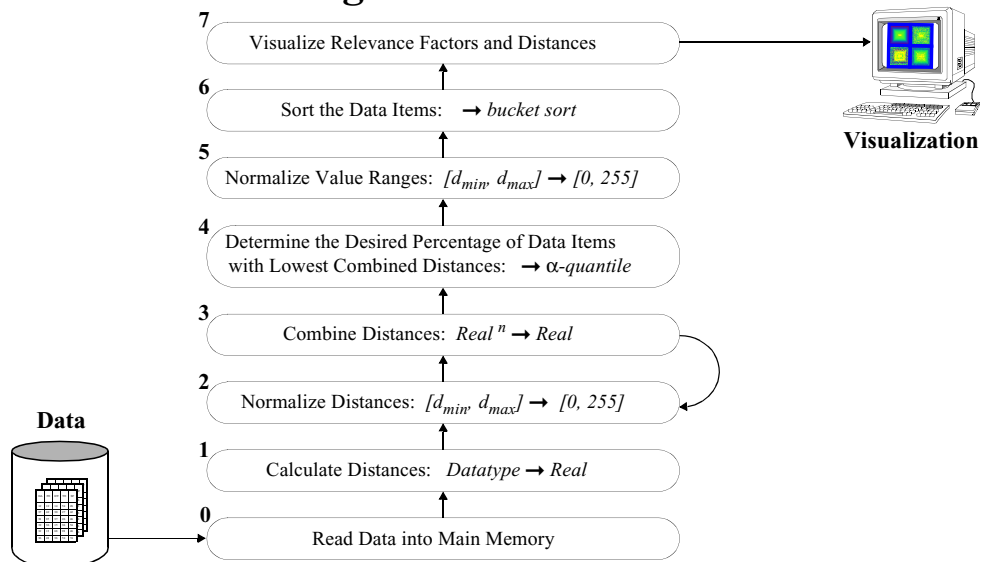

# Pixel-oriented Techniques

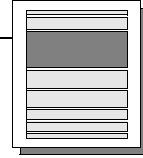

## Query-Dependent Techniques: Spiral Technique [KKS 93, KK 94]

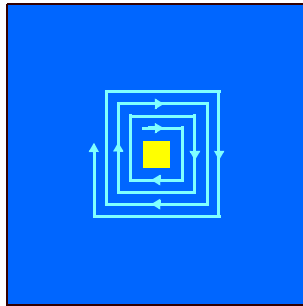

arrangement in spiral form  
according to the overall distance

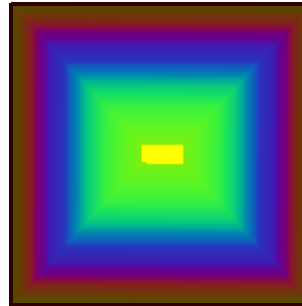

example of the  
overall distance

# Pixel-oriented Techniques

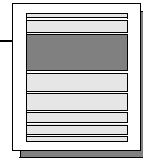

## Spiral Technique (cont'd)

- the values for each of the attributes are presented in a separate subwindows
- the arrangement inside the subwindows is according to the overall distance
- example:

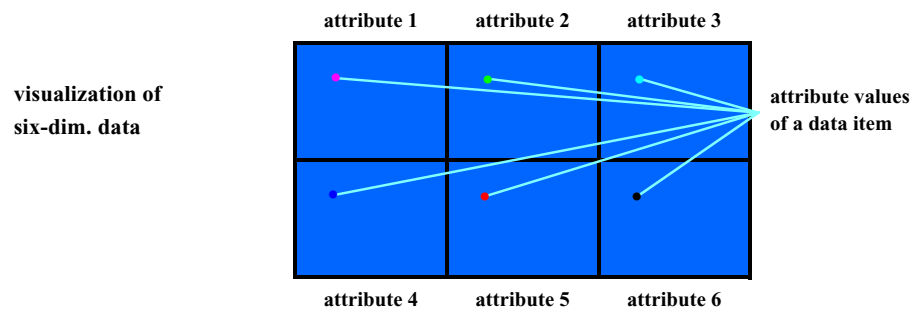

# Pixel-oriented Techniques

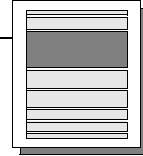

## Spiral Technique (cont'd)

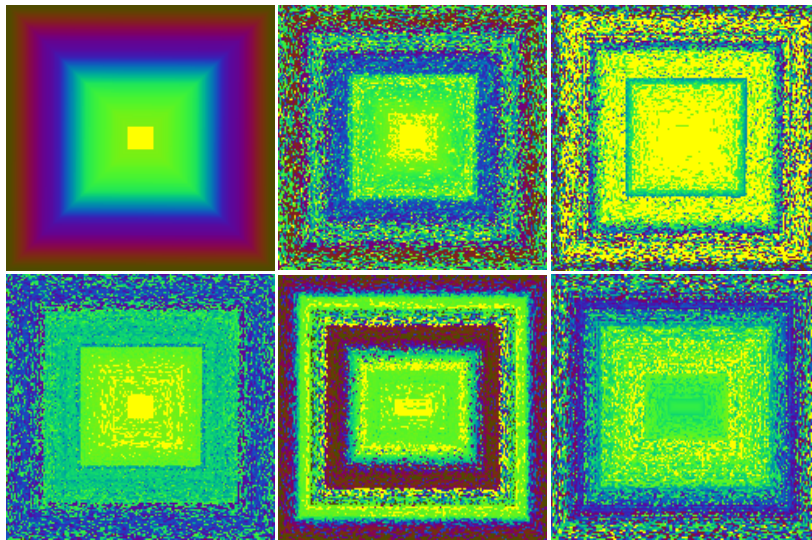

result of a complex query

# Pixel-oriented Techniques

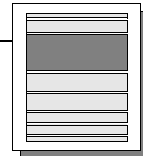

## Axes Technique [KK 94]

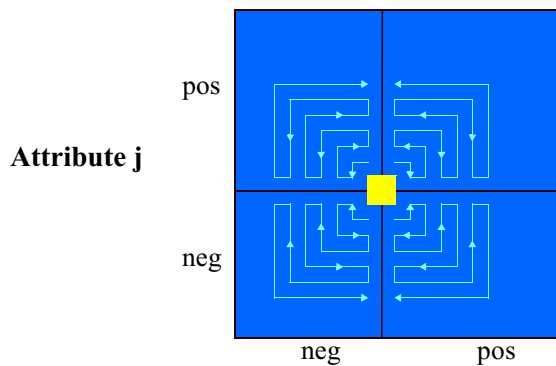

arrangement in partial spirals in each quadrant

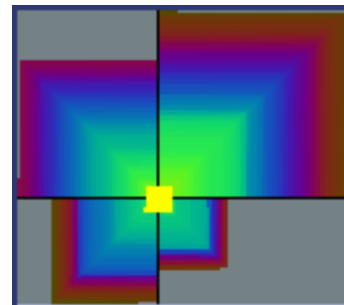

example of the overall distance

# Pixel-oriented Techniques

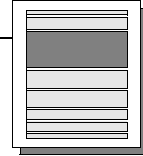

## Spiral and Axes Techniques [KK 94]

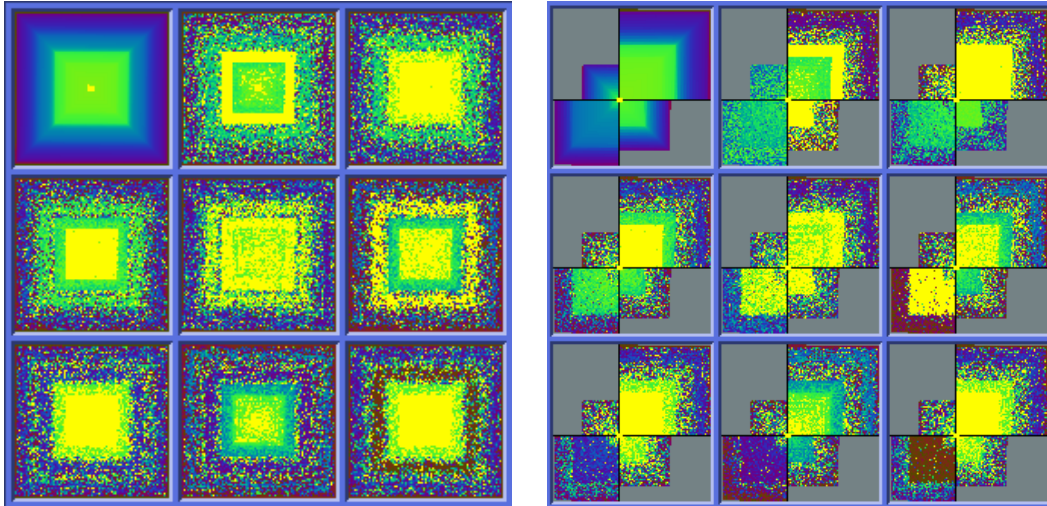

random data containing several clusters

# Pixel-oriented Techniques

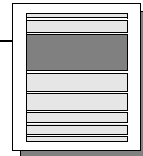

## Spiral, Axes, and Color Icon Techniques [KK 94]

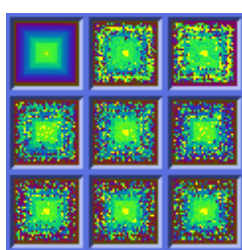

Spiral Technique

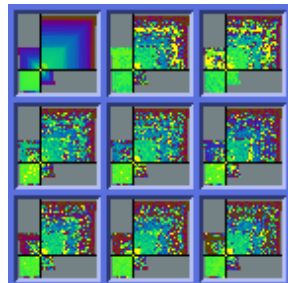

Axes Technique

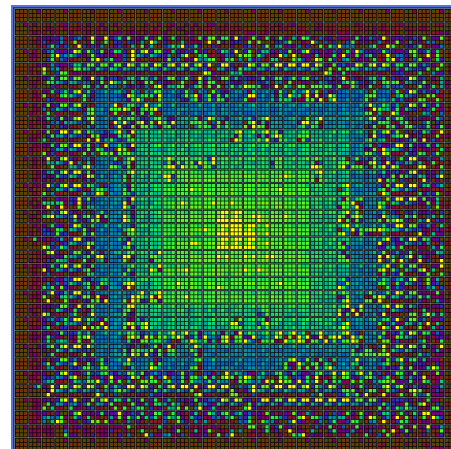

Color Icon Technique



# Pixel-oriented Techniques

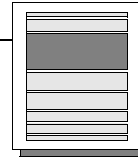

## Generalized Spiral Technique [Kei 95]

⇔ Combination of Spiral Technique and Space-Filling Curves

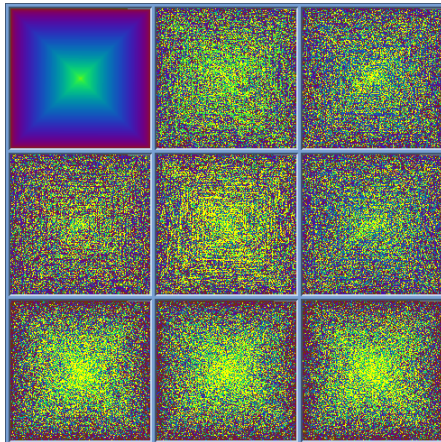

**Spiral Technique**

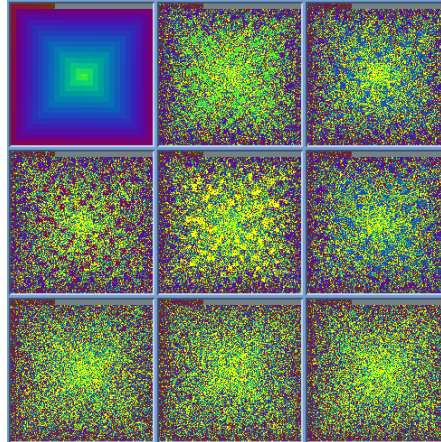

**Snake-Spiral Technique**

# Pixel-oriented Techniques

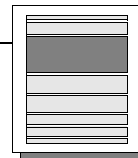

## Circle Segments Technique [AKK 96]

⇔ Arrangement of Attributes on the Segments of a Circle

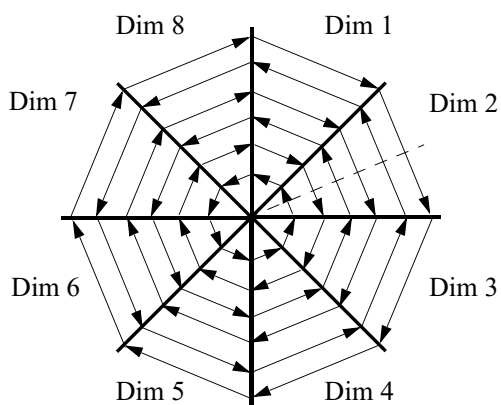

**Arrangement of 8-dim. Data**

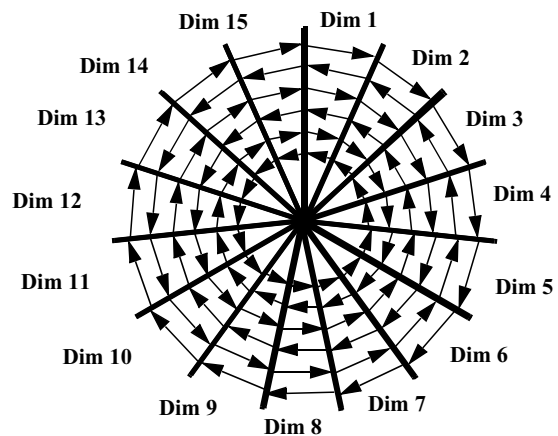

**Arrangement of 15-dim. Data**

## Pixel-oriented Techniques

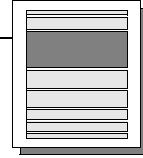

### Circle Segments Technique (cont'd)

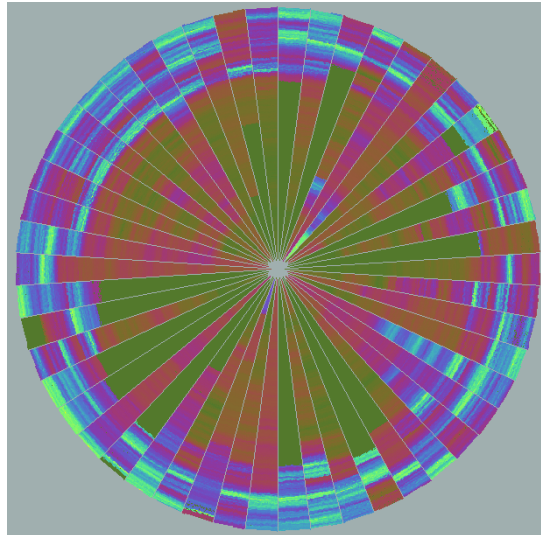

time series of  
50 stocks of  
the Frankfurt  
Stock Index

## Hierarchical Techniques

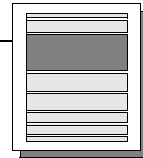

**Basic Idea:** Visualization of the data using a hierarchical partitioning into subspaces.

### Overview

- Dimensional Stacking [LWW 90]
- Worlds-within-Worlds [FB 90a/b]
- Treemap [Shn 92, Joh 93]
- Cone Trees [RMC 91]
- InfoCube [RG 93]

# Hierarchical Techniques

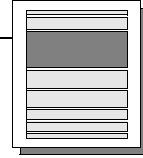

## Dimensional Stacking [LWW 90]

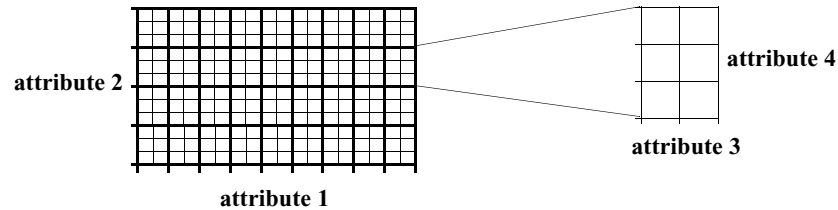

- ⇒ partitioning of the n-dimensional attribute space in 2-dimensional subspaces which are 'stacked' into each other
- ⇒ partitioning of the attribute value ranges into classes
- ⇒ the important attributes should be used on the outer levels
- ⇒ adequate especially for data with ordinal attributes of low cardinality

# Hierarchical Techniques

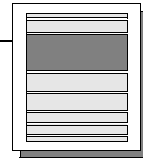

## Dimensional Stacking (cont'd)

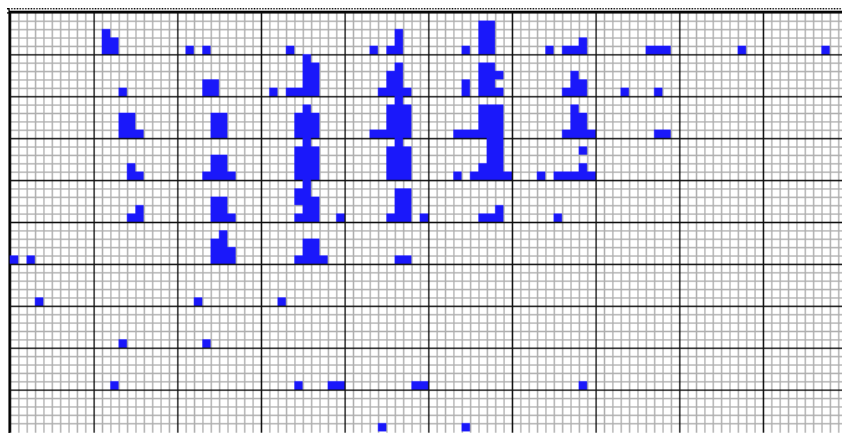

visualization of oil mining data with longitude and latitude mapped to the outer x-, y- axes and ore grade and depth mapped to the inner x-, y- axes

used by permission of M. Ward, Worcester Polytechnic Institute



# Hierarchical Techniques

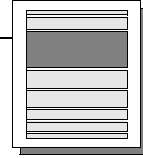

## Worlds-within-Worlds [FB 90a/b]

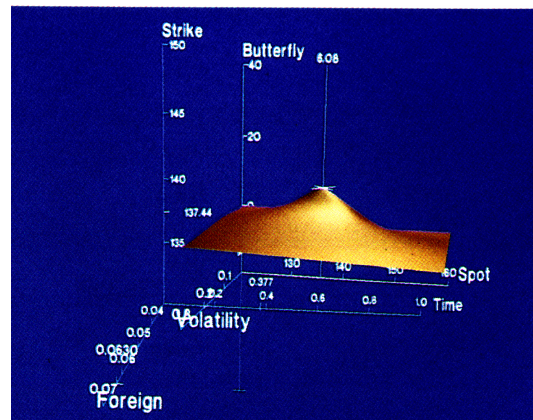

visualization of a six-dim. function

used by permission of C. Beshers, S. Feiner, Columbia University

- ⇒ partitioning of the n-dim. space into 3-dim. subspaces (e.g., a six-dim. object is displayed by having a new coordinate system for the last three dimensions sit inside the coordinate system for the first three)

# Hierarchical Techniques

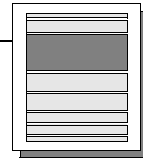

## Treemap [JS 91, Shn 92, Joh 93]

- ⇒ screen-filling method which uses a hierarchical partitioning of the screen into regions depending on the attribute values
- ⇒ the x- and y-dimension of the screen are partitioned alternately according to the attribute values (the attribute value ranges have to be partitioned into classes)
- ⇒ the attributes used for the partitioning and their ordering are user-defined (the most important attributes should be used first)
- ⇒ the color of the regions may correspond to an additional attribute
- ⇒ suitable to get an overview over large amounts of hierarchical data (e.g., file system) and for data with multiple ordinal attributes (e.g., census data)

# Hierarchical Techniques

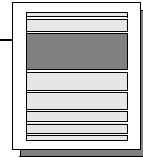

## Treemap (cont'd)

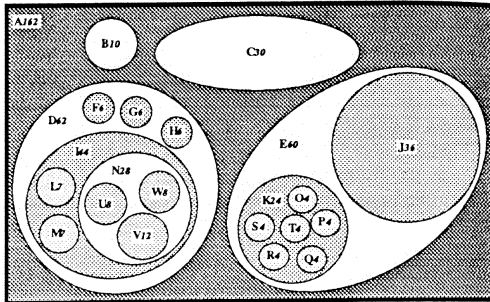

used by permission of B. Shneiderman, University of Maryland

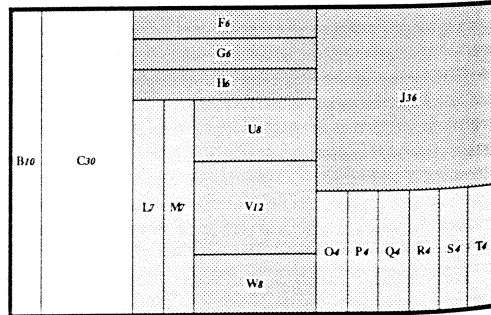

used by permission of B. Shneiderman, University of Maryland

Venn Diagram

Tree-Map

# Hierarchical Techniques

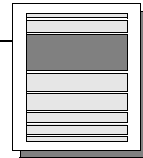

## Treemap (cont'd)

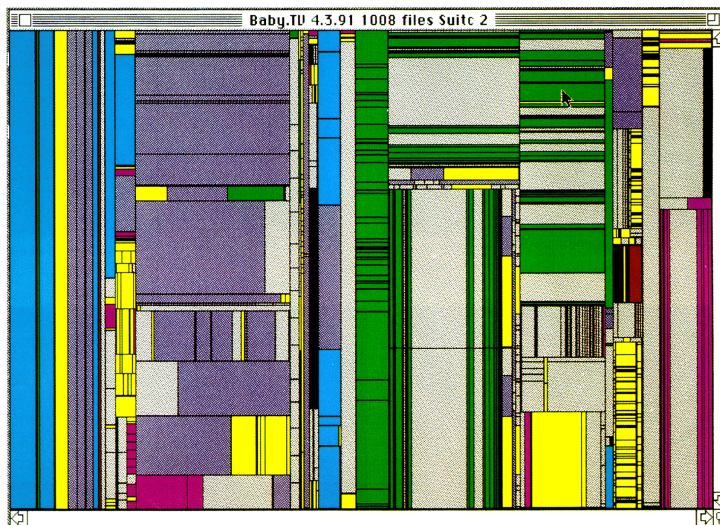

used by permission of B. Shneiderman, University of Maryland

treemap of a  
file system  
containing about  
1000 files

# Hierarchical Techniques

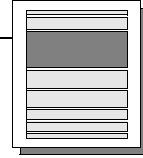

## Cone Trees [RMC 91, CK 95]

⇒ animated 3D visualizations of hierarchical data

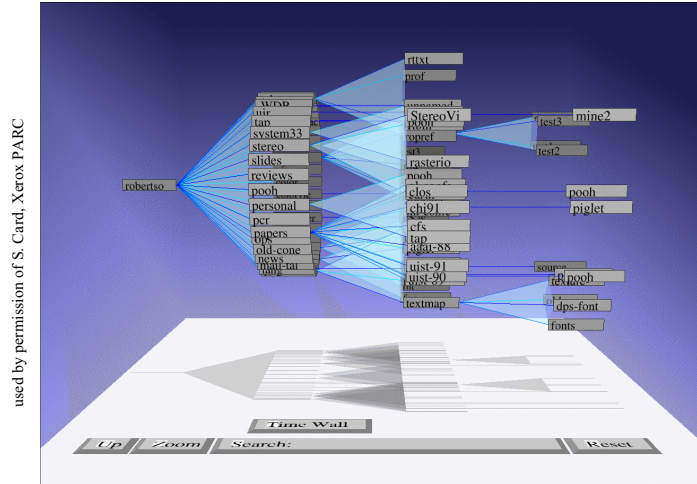

used by permission of S. Card, Xerox PARC

file system structure  
visualized as a  
cone tree

# Hierarchical Techniques

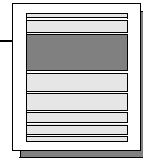

## InfoCube [RG 93]

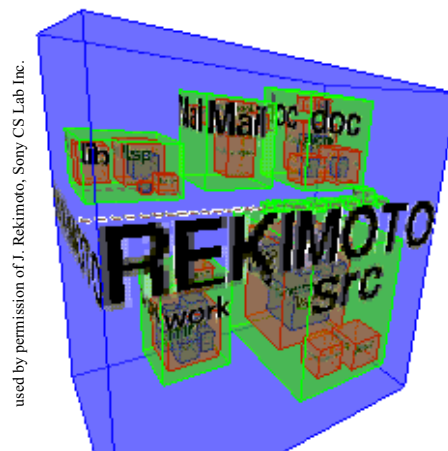

used by permission of J. Rekimoto, Sony CS Lab Inc.

visualization of  
a file system  
structure

⇒ 3D visualization of hierarchical data using transparent boxes

# Graph-based Techniques

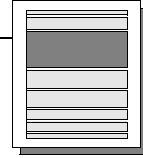

**Basic Idea:** Visualization of large graphs using techniques to convey the meaning of the graph clearly and quickly.

## Overview [CT 94, BETT 94]

- ❑ **Basic Graphs** (e.g., Straight-Line, Polyline, Curved-Line, Orthogonal Graphs, ...)
- ❑ **Specific Graphs** (e.g., Directed Acyclic, Cluster-Optimized, Symmetry-Optimized Graphs, Hygraphs, ...)
- ❑ **Systems** (e.g., Tom Sawyer, Hy<sup>+</sup> [CM 93, Con 94], SeeNet [EW 93, BEW 95], Narcissus [HDWB 95], ...)

# Graph-based Techniques

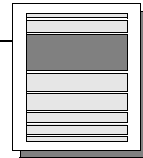

## 2D-Graph Drawings

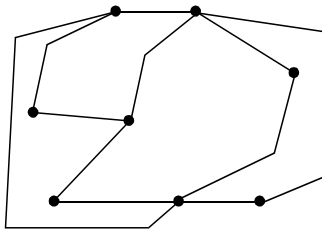

Polyline Drawing

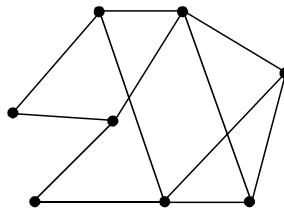

Straight-Line Drawing

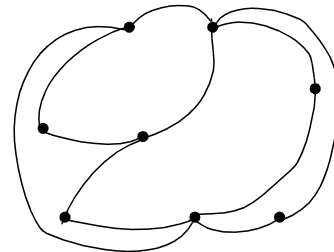

Curved-Line Drawing

# Graph-based Techniques

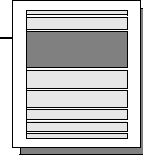

## Properties of 2D-Graph Drawings

- planarity (no line crossings)
- orthogonality (only orthogonal lines)
- grid property (coordinates of vertices are integers)

## Aesthetics Properties (Optimization Goals)

- minimal number of line crossings
- optimal display of symmetries
- optimal display of clusters
- minimal number of bends in polyline graphs
- uniform distribution of vertices
- uniform edge lengths

# Graph-based Techniques

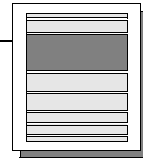

## 2D-Graph Drawings (Examples)

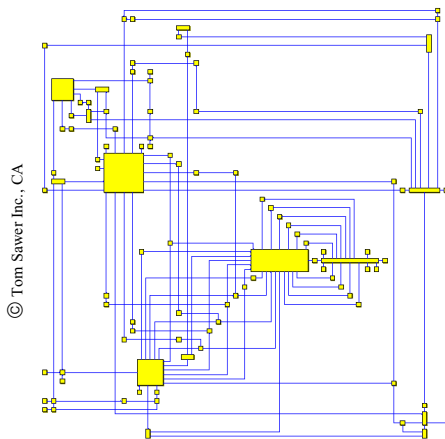

**Orthogonal Graph**

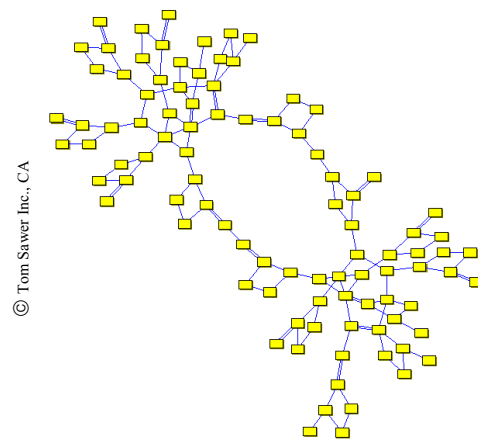

**Symmetry-Optimized Graph**

# Graph-based Techniques

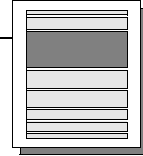

## 2D-Graph Drawings (Examples)

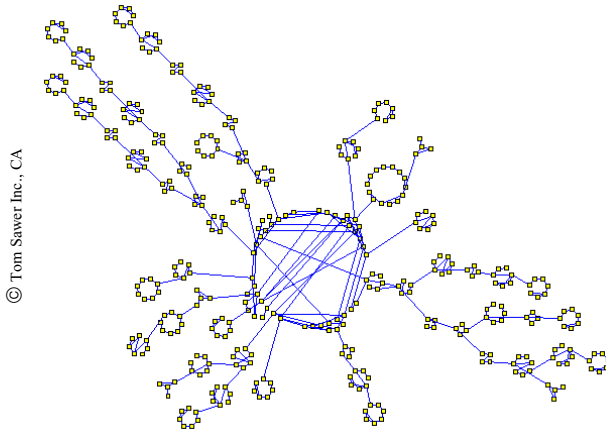

© Tom Sawyer Inc., CA

**Cluster-Optimized Graph**

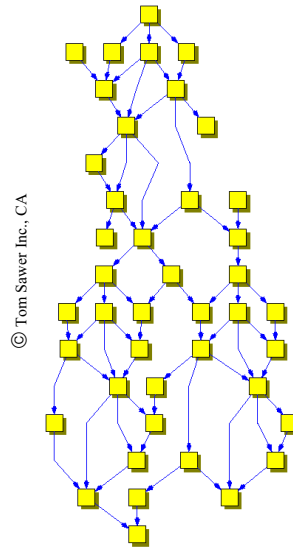

© Tom Sawyer Inc., CA

**Directed  
Acyclic  
Graph**

# Graph-based Techniques

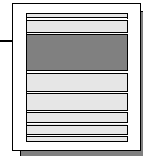

## 2D-Graph Drawings: Open Problems [BETT 94]

- Performance Bounds (e.g. for planarization, ...)
- Dynamic Algorithms
- Parallel Algorithms
- Complexity of Bend Minimization
- Angular Resolution Constraints
- Three-dimensional Graph Drawings



# Graph-based Techniques

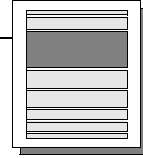

## 3D-Graph Drawings (cf. [CELR 94])

used by permission of A. Frick, University of Karlsruhe

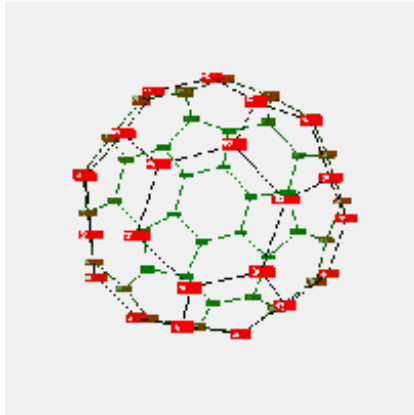

**Ball-like Graph**

used by permission of A. Frick, University of Karlsruhe

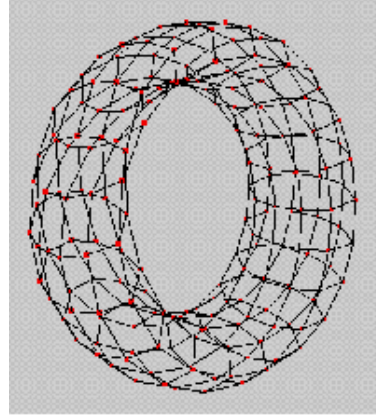

**Torus-like Graph**

# Graph-based Techniques

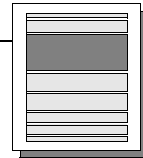

## 3D-Graph Drawings (cont'd)

used by permission of A. Frick, University of Karlsruhe

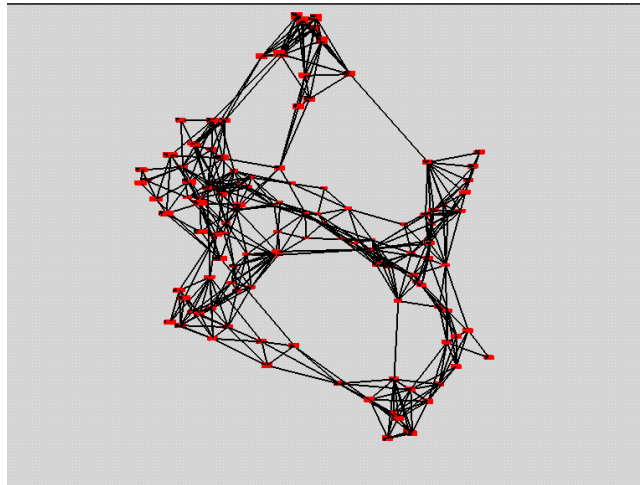

**Cluster-Optimized 3D-Graph**

# Graph-based Techniques

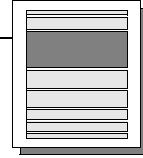

## Hygraphs (cont'd)

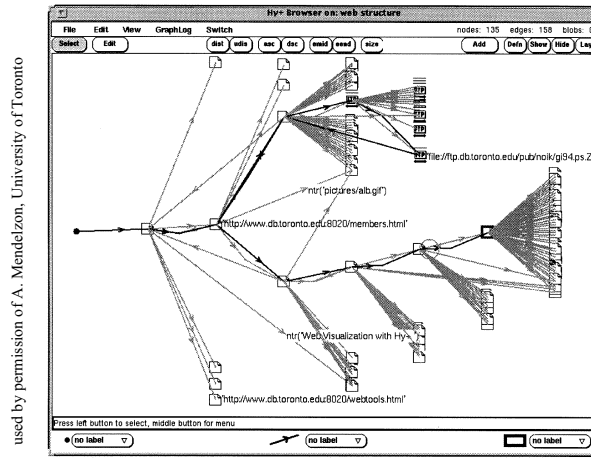

visualization of a web browsing session

- ⇒ multi-resolution visualization of hygraphs allowing an interactive manipulation using Graphlog

# Graph-based Techniques

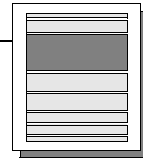

## SeeNet [EW 93, BEW 95]

- ⇒ visualization of hierarchical networks with weighted links
- ⇒ special features of SeeNet:
  - semantic node placement (minimizing the distance of nodes with high-weighted links)
  - attributes are mapped to size and color of nodes and links
  - interactivity for - changing the mappings
    - expanding or collapsing nodes within the hierarchy
    - getting additional information, etc.
- ⇒ mappings in the example:
  - size of nodes: number of e-mail messages of a person
  - color of nodes: function of staff members
  - size of links: number of e-mail messages of the link
  - color of links: blue for few through green and yellow to red for many messages



# Graph-based Techniques

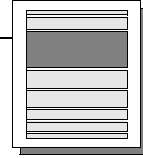

## SeeNet (cont'd)

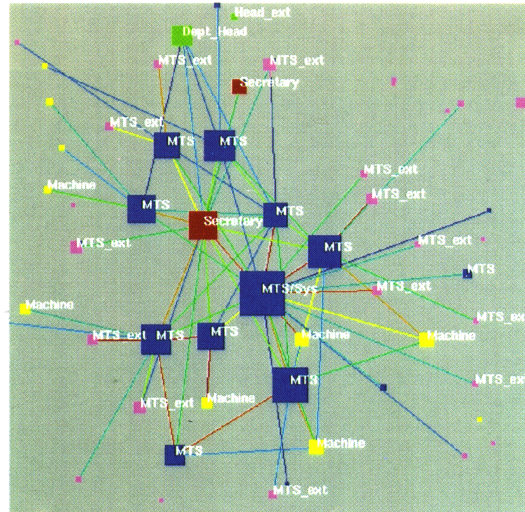

used by permission of S. Eick, Bell Labs

visualization of all e-mail connections in a department over a period of time

# Graph-based Techniques

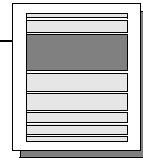

## Narcissus [HDWB 95]

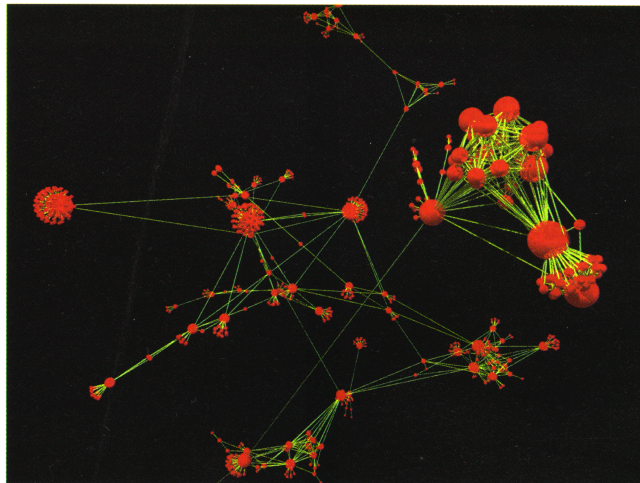

used by permission of B. Hendley, University of Birmingham

visualization of a large number of web pages

⇒ visualization of complex highly interconnected data (e.g., graphs such as the web)

## Hybrid Techniques

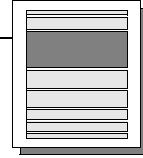

**Basic Idea:** Integrated use of multiple techniques in one or multiple windows to enhance the expressiveness of the visualizations.

- ⇒ linking diverse visualization techniques may provide additional information
- ⇒ virtually all visualization techniques are combined with dynamics & interactivity

**Examples:** IVEE [AW 95a/b] uses *Starfield Displays* [AS 94] which are scatterplots of icons with dynamic zooming and mapping (combination of geometric, icon-based, and dynamic techniques)

XmDv [War 94] allows to dynamically link and brush scatterplot matrices, star icons, parallel coordinates, and dimensional stacking (combination of geometric, icon-based, hierarchical and dynamic techniques)

## Distortion Techniques

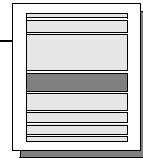

**Basic Idea:** Distortion of the image to allow a visualization of larger amounts of data

### Overview [LA 94]

- **Simple:**
  - Perspective Wall [MRC 91]
  - Bifocal Displays [SA 82]
  - TableLens [RC 94]
  - Graph. Fisheye Views [Fur 86, SB 94]
  - Hyperbolic Repr. [LR 94, LRP 95]
- **Complex:**
  - Hyperbolic Repr. [LR 94, LRP 95]
  - 3D-Hyperbolic Repr. [MB 95]
  - Hyperbox [AC 91]

# Distortion Techniques

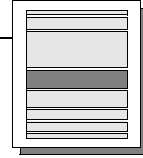

## Perspective Wall [MRC 91]

- ⇒ presentation of the data on a perspective wall
- ⇒ the data outside the focal area are perspectively reduced in size
- ⇒ the perspective wall is a variant of the bifocal lens display [SA 82] which horizontally compresses the sides of the workspace by direct scaling

# Distortion Techniques

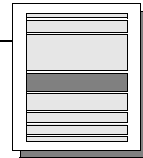

## Perspective Wall (cont'd)

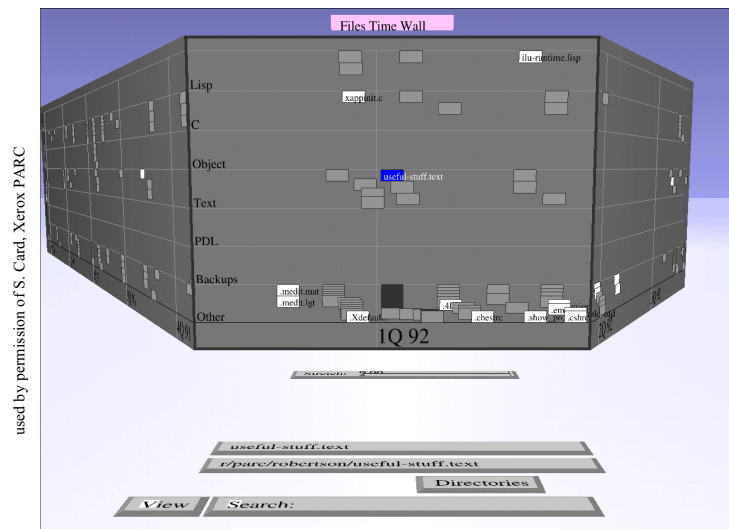

documents  
arranged on a  
perspective wall

# Distortion Techniques

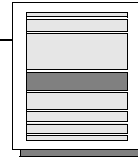

## Table Lens [RC 94]

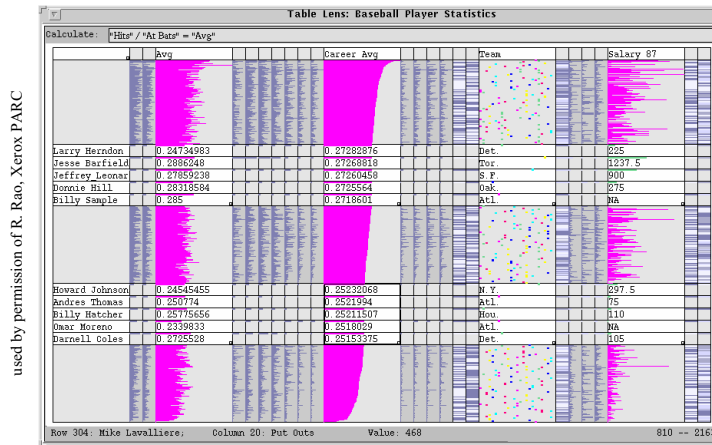

visualization of a baseball database with a few rows being selected in full detail

- ⇒ compact visualization of a table (spreadsheet / database) with the possibility of viewing portions of the table in more detail

# Distortion Techniques

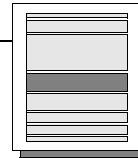

## Fisheye View [Fur 86, SB 94]

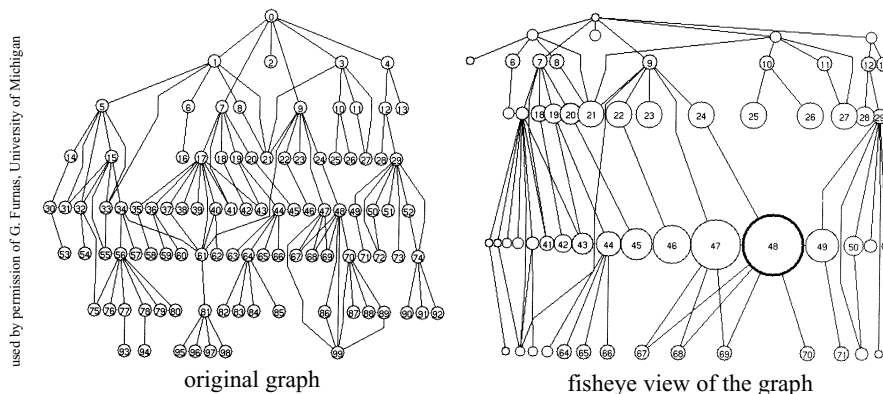

- ⇒ graph visualization using a fisheye perspective
- ⇒ shows an area of interest quite large and with detail and the other areas successively smaller and in less detail

# Distortion Techniques

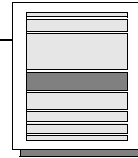

## Hyperbolic Trees [LR 94, LRP 95]

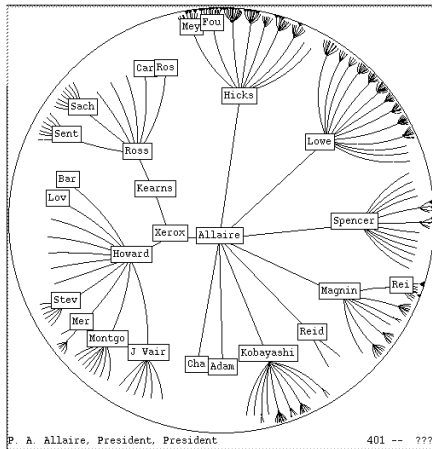

P. A. Allaire, President, President 401 -- ???

used by permission of R. Rao, Xerox PARC

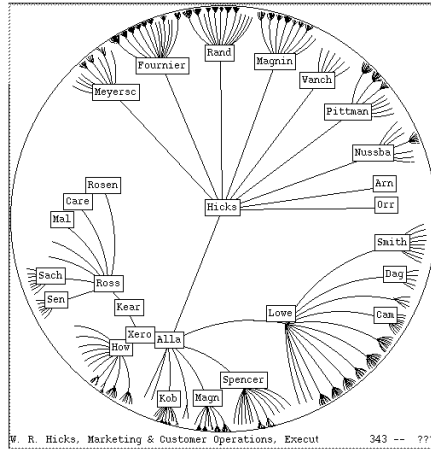

W. R. Hicks, Marketing & Customer Operations, Execut 343 -- ???

used by permission of R. Rao, Xerox PARC

visualization of a large organizational hierarchy

⇒ visualization of a tree structure in hyperbolic space with different foci

# Distortion Techniques

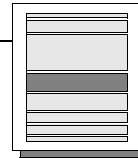

## 3D-Hyperbolic Representation [MB 95, MHCF 96]

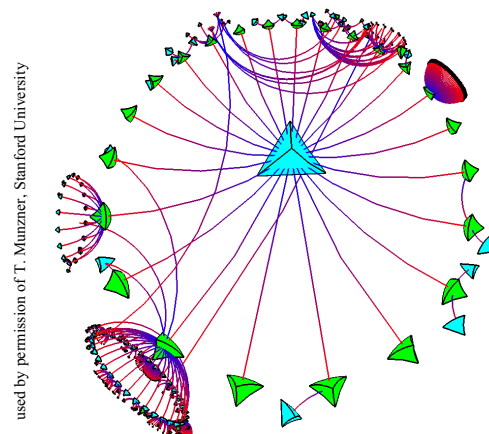

used by permission of T. Munzner, Stanford University

visualization of a large number of connected web-pages

⇒ visualization of a graph in 3D hyperbolic conetree-like representation

# Distortion Techniques

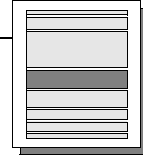

## Hyperbox [AC 91]

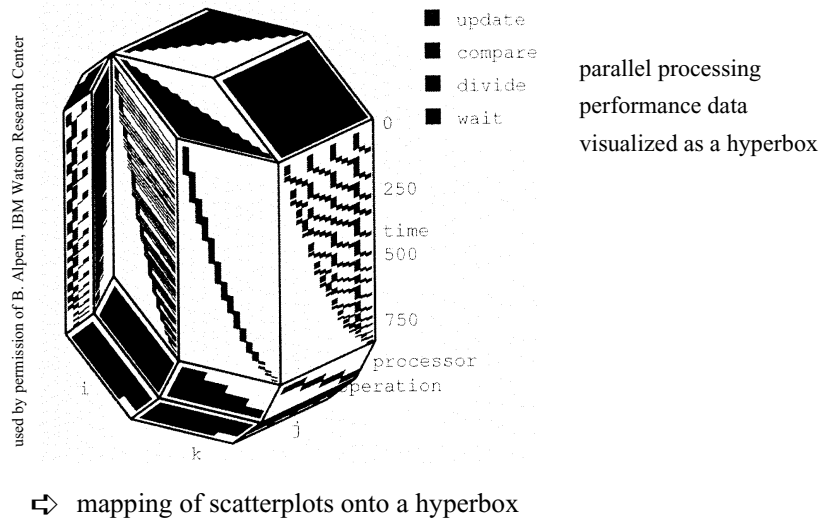

# Dynamic / Interaction Techniques

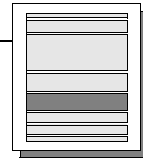

**Basic Idea:** Dynamic generation of the visualizations or interaction with the visualization for a more effective exploration of the data.

## Overview

- Data-to-Visualization Mapping
- Projections
- Filtering (Selection, Querying)
- Linking & Brushing
- Zooming
- Detail on Demand

## Dynamic / Interaction Techniques

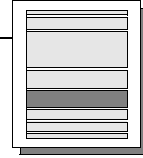

### □ Dynamic / Interactive Data-to-Visualization Mapping

- ⇒ dynamic or interactive mapping of the data attributes to the parameters of the visualization
- ⇒ parameters of the visualization are
  - x-, y-, and z-axes
  - color and size of icons, links, etc.
- ⇒ examples:
  - AutoVisual [BF 93]
  - S Plus [BCW 88]
  - XGobi [SCB 92, BCS 96]
  - IVEE / Spotfire [AW 95a/b]
  - SDM [CRMK 95], ...

## Dynamic / Interaction Techniques

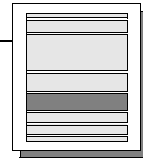

### □ Dynamic / Interactive Projections

- ⇒ dynamic or interactive variation of the projections
- ⇒ visualization of the remaining parameters in 2D or 3D
- ⇒ automatic variation results in an animation of the data
- ⇒ examples:
  - GrandTour [Asi 85]
  - S Plus [BCW 88]
  - XGobi [SCB 92, BCS 96]
  - Influence & Attribute Explorer [STDS 95, SDTS 95]
  - ...



## Dynamic / Interaction Techniques

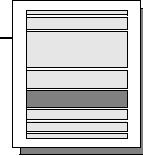

### □ Dynamic / Interactive Filtering

- ⇒ dynamic or interactive determination of subsets of the database
- ⇒ distinction between
  - **selection**: direct selection of the desired subset
  - **querying**: specification of properties of the desired subset
- ⇒ specific problem: specification of complex boolean conditions
- ⇒ examples:
  - Magic Lenses [Bie 93] / Moveable Filter [FS 95]
  - Filter-Flow Model [YS 93]
  - InfoCrystal [Spo 93]
  - DEVise [Liv 97]
  - Dynamic Queries [AS 94, Eic 94, GR 94]
  - ...

## Dynamic / Interaction Techniques

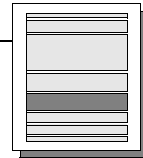

### Magic Lenses / Moveable Filter [Bie 93, SFB 94, FS 95]

- ⇒ interactive selection using lens-like tools which selectively filter the data in the considered areas
- ⇒ multiple lenses / moveable filters can be used for a multi-level filtering (allowing complex conditions)



# Dynamic / Interaction Techniques

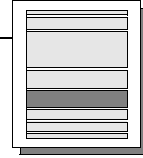

## Filter-Flow Model [YS 93]

- ⇒ selection based on a dataflow-oriented model:  
the data flows through filter-units which reduce the flow
- ⇒ especially useful for an intuitive specification of complex boolean queries:
  - AND-connected query portions may be specified using multiple filter units in a pipeline fashion
  - OR-connected query portions may be specified using multiple independent flows which reunite into a single bigger flow

# Dynamic / Interaction Techniques

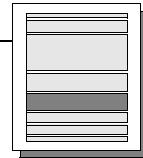

## Filter-Flow Model (cont'd)

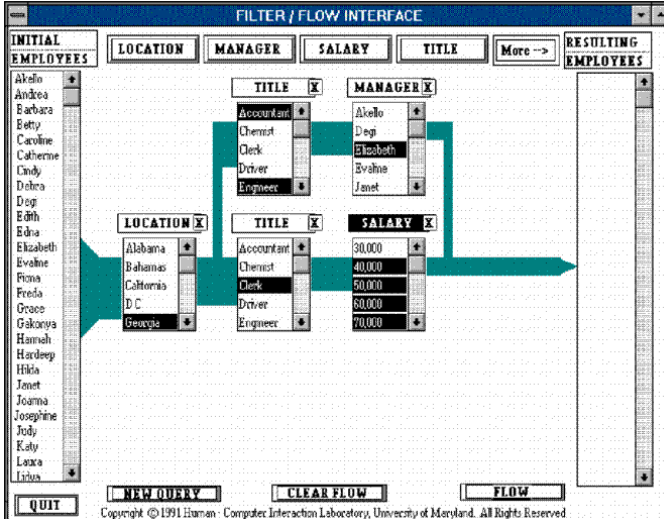

The screenshot shows a software interface titled "FILTER / FLOW INTERFACE". It features a list of employee names on the left, a central area with several filter units (LOCATION, TITLE, MANAGER, SALARY) connected by green arrows, and a "RESULTING EMPLOYEES" list on the right. The filter units are configured to find employees from Georgia who are managed by Elizabeth, or the clerks from Georgia who make more than 30,000. The interface includes buttons for "NEW QUERY", "CLEAR FLOW", and "FLOW".

used by permission of B. Shneiderman, University of Maryland

Copyright © 1991 Itaman - Computer Interaction Laboratory, University of Maryland. All Rights Reserved

complex boolean query:

Find the accountants or engineers from Georgia who are managed by Elizabeth, or the clerks from Georgia who make more than 30,000!

# Dynamic / Interaction Techniques

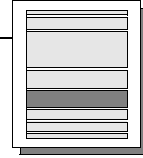

## InfoCrystal [Spo 93]

- ⇒ specification of complex boolean queries using an intuitive model for specifying complex subsets
- ⇒ basic idea:

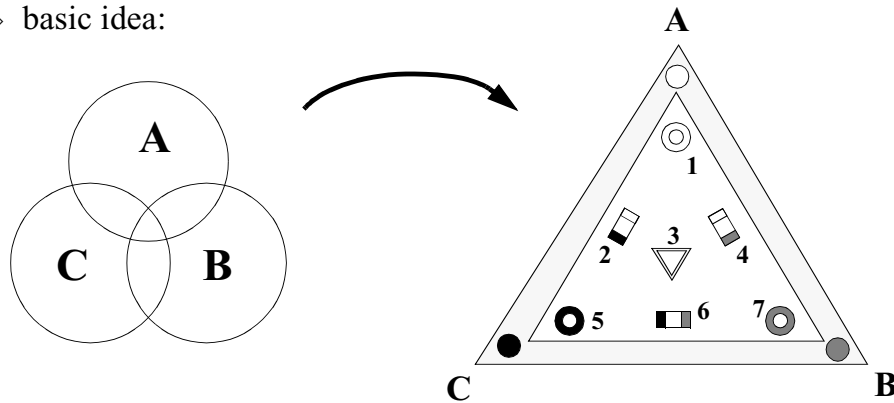

# Dynamic / Interaction Techniques

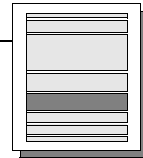

## DEVisE [Liv 97]

- ⇒ tool set for the construction of interactive visualizations

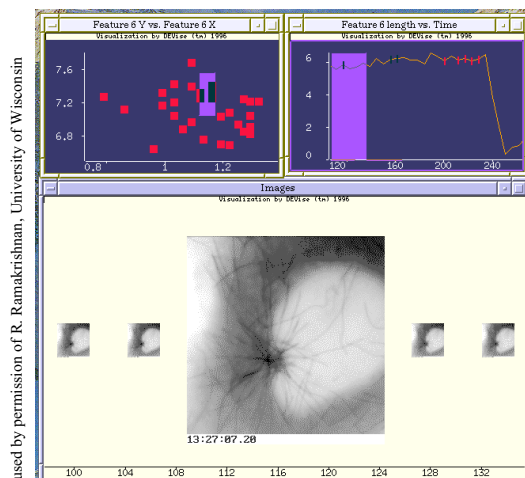

interactive selection  
of data items in the  
upper two subwindows

# Dynamic / Interaction Techniques

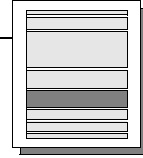

## □ Dynamic / Interactive Linking & Brushing

- ⇒ prerequisite: multiple visualizations of the same data (e.g., visualizations of different projections)
- ⇒ interactive changes made in one visualization are automatically reflected in the other visualizations
- ⇒ examples:
  - Xmdv-Tool [War 94]
  - S Plus [BCW 88]
  - XGobi [SCB 92, BCS 96]
  - DataDesk [Vel 92, WUT 95]
  - ...

# Dynamic / Interaction Techniques

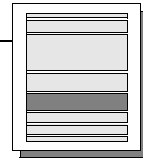

## XGobi [SCB 92, BSC 96]

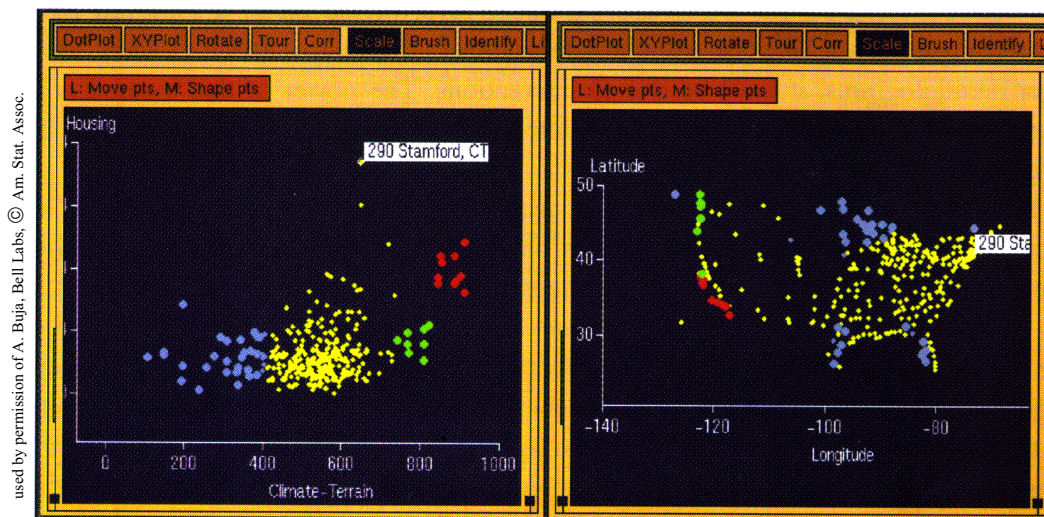

climate and housing data of the US

taken from [BSC 96]

# Dynamic / Interaction Techniques

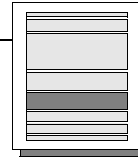

## ❑ Dynamic / Interactive Zooming

- ⇒ visualization of large amounts of data in reduced form to provide an overview of the data
- ⇒ variable zooming of the data with automatic changes of the visualization modes to present more details
- ⇒ examples:
  - PAD++ [PF 93, Bed 94, BH 94]
  - IVEE [AW 95a/b]
  - DataSpace [ADLP 95]
  - ...
- ⇒ a comparison of fisheye and zooming techniques can be found in [Sch 93]

# Dynamic / Interaction Techniques

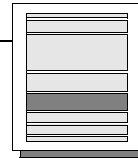

## IVEE / Spotfire [AW 95a/b]

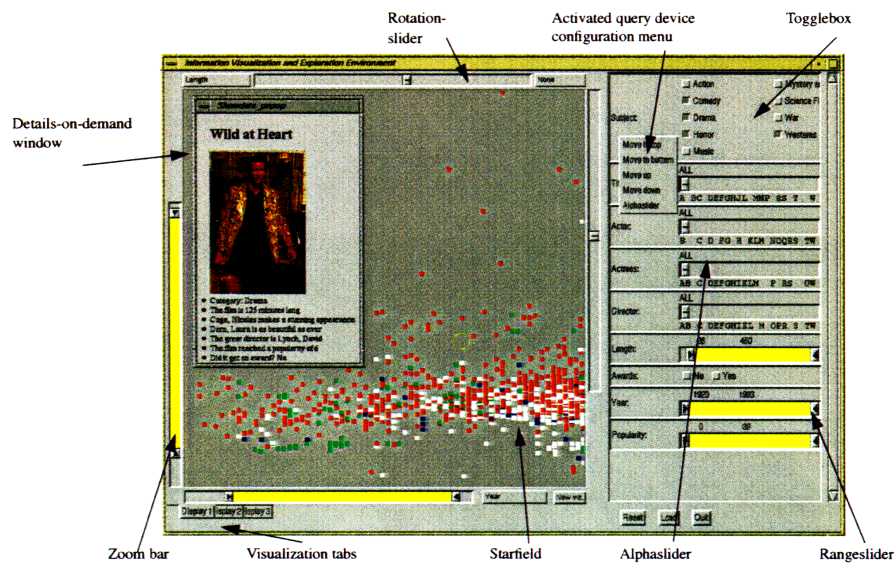

Rotation-slider

Activated query device configuration menu

Togglebox

Details-on-demand window

Zoom bar

Visualization tabs

Starfield

Alphaslider

Rangeslider

used by permission of C. Ahlberg: IVEE Development

# Dynamic / Interaction Techniques

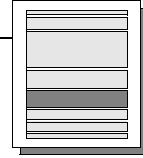

## ❑ Interactive Details on Demand

- ⇒ the possibility to interactively obtain more details of the visualized data
- ⇒ details are, for example, the attribute values corresponding to an icon or additional attribute values of a data item
- ⇒ examples:
  - IVEE / Spotfire [AW 95a/b]
  - Table Lens [RC 94]
  - Magic Lens [Bie 93]
  - VisDB [KK 94, KK 95]
  - ...

# Dynamic / Interaction Techniques

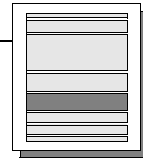

## VisDB [Kei 94]

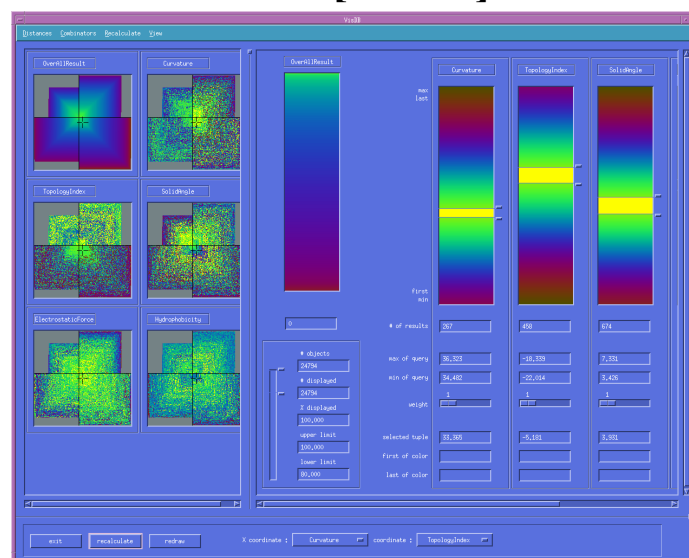



# Comparison of the Techniques

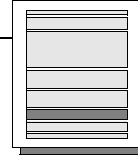

## Criteria for Comparison [KK 96]

comparison of the described information visualization techniques based on their suitability for certain

- ⇒ **data characteristics**  
(e.g., no. of variates, no. of data items, categorical data, ...)
- ⇒ **task characteristics**  
(e.g., clustering, multi variate hot spots, ...)
- ⇒ **visualization characteristics**  
(e.g., visual overlap, learning curve, ...)

**Disclaimer:** The following comparison table expresses my personal opinion obtained from reading the literature and experimenting with several of the described techniques. Many of the ratings are arguable and largely depend on the considered data, the exploration task, experience of the user, etc. In addition, implementations of the techniques in real systems usually avoid the drawbacks of a single technique by combining it with other techniques, which is also not reflected in the ratings.

# Comparison of the Techniques

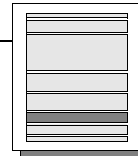

## Comparison: An Attempt

		clustering	multi-variate hot spot	no. of variates	no. of data items	categorical data	visual overlap	learning curve
Geometric Techniques	Scatterplot Matrices	++	++	+	+	-	o	++
	Landscapes	+	+	-	o	o	+	+
	Prosection Views	++	++	+	+	-	o	+
	Hyperslice	+	+	+	+	-	o	o
	Parallel Coordinates	o	++	++	-	o	--	o
Icon-based Techniques	Stick Figure	o	o	+	-	-	-	o
	Shape Coding	o	-	++	+	-	+	-
	Color Icon	o	-	++	+	-	+	-
Pixel-oriented Techniques	Query-Independent	+	+	++	++	-	++	+
	Query-Dependent	+	+	++	++	-	++	-
Hierarchical Techniques	Dimensional Stacking	+	+	o	o	++	o	o
	Worlds-within-Worlds	o	o	o	+	o	o	o
	Treemap	+	o	+	o	++	+	o
	Cone Trees	+	+	o	+	o	+	+
	InfoCube	o	o	-	-	o	o	+



# Database Visualization Systems

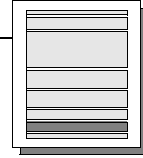

## Overview

- ❑ **Statistics-oriented Systems**
- ❑ **Visualization-oriented Systems**
- ❑ **Database-oriented Systems**
- ❑ **Special Purpose Visualization Systems**

# Database Visualization Systems

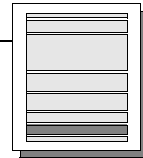

- ❑ **Statistics-oriented Systems**
  - ⇒ S Plus [BCW 88] / Trellis [BCS 96]  
(-> generic system for statistical analysis and visualization)
  - ⇒ XGobi [XGobi, SCB 92, BSC 96]  
(-> extensible lisp-based system for statistical analysis and visualization)
  - ⇒ Data Desk [Vel 92, WUT 95]  
(-> commercial system for statistical analysis and visualization;  
features: dyn. linking & brushing of scatterplots and histograms)
  - ⇒ Diamond (SPSS)  
(-> commercial system for statistical analysis and visualization;  
features: dyn. linking & brushing of scatterplots, parallel coordinates, etc.)
  - ⇒ DataSpace [ADLP 95]  
(-> 3D-arrangement of a large number of arbitrary visualizations)

# Database Visualization Systems

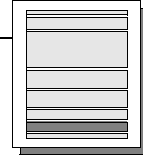

## □ Visualization-oriented Systems

- ⇒ ExVis [GPW 89]  
(-> features: stick figure and other icon-based techniques)
- ⇒ Parallel Visual Explorer (IBM)  
(-> features: parallel coordinate technique with query-based coloring, etc.)
- ⇒ XmDv [War 94, MW 95]  
(-> features: scatterplot matrices, star icons, parallel coordinates, dimensional stacking, dynamic linking and brushing)
- ⇒ Influence & Attribute Explorer [STDS 95, SDTS 95]  
(-> features: scatterplot and projection matrices, histograms, dynamic linking and brushing)
- ⇒ Information Visualizer (Xerox) [HC 86, CRY 96]  
(-> features: diverse information visualization techniques including perspective wall, table lens, cone trees)

# Database Visualization Systems

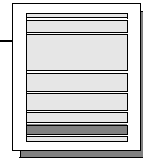

## □ Database-oriented Systems

- ⇒ Hy<sup>+</sup> [CM 93]  
(-> features: query and visualizations of hygraphs)
- ⇒ TreeViz [Joh 93]  
(-> features: treemap technique)
- ⇒ VisDB [KK 94, KK 95]  
(-> system for interactive slider-based exploration of very large databases  
features: stick figure, parallel coordinate, and pixel-oriented techniques)
- ⇒ IVEE [AW 95a/b] / Spotfire  
(-> commercial system for database exploration;  
features: generic interactive slider-based visualization environment)
- ⇒ DEVise [Liv 97]  
(-> system for the generation of interactive special purpose database visualizations)

# Database Visualization Systems

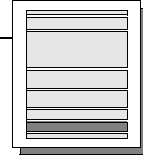

## ❑ Special Purpose Visualization Systems

- ⇒ Software & Algorithm Visualization  
(e.g., SeeSoft [ESS 92, BE 96] - a listing of Software & Algorithm Interfaces can be found under “<http://www.broy.informatik.tu-muenchen.de/~trilk/sv.html>” for an overview paper see [SP 92])
- ⇒ Web Visualization  
(e.g., Narcissus [HDWB 95], WebBook and WebForager [CRY 96] - a listing of Web Visualization Interfaces can be found under “[http://www.geog.ucl.ac.uk/casa/martin/geography\\_of\\_cyberspace.html](http://www.geog.ucl.ac.uk/casa/martin/geography_of_cyberspace.html)”)
- ⇒ Visualization in Information Retrieval  
(e.g., Vibe [Ols 93] - a listing of Information Retrieval Interfaces can be found under “<http://www.cui.darmstadt.gmd.de/visit/Activities/Viri/visual.html>”; for an overview paper see [Car 96])

# Summary and Conclusions

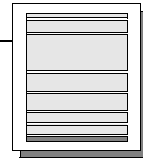

## Summary

- ❑ there are a number of recently developed visualization techniques which are applicable to database exploration
- ❑ there are different techniques for different types of data (relational tables, hierarchies, graphs, etc.)
- ❑ many of the techniques are applicable to traditional relational information sources
- ❑ there are a number of research prototypes and commercial systems available

# Summary and Conclusions

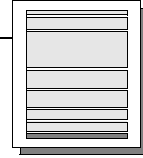

## Research Issues

- development of integrated information visualization and exploration systems  
(integration with techniques from statistics, machine learning, databases, ...)
- in-depth evaluation and comparison of visualization techniques for database exploration (-> possibilities for improvement)
- using more dynamics & interaction to steer the mining process
- case studies in a variety of application areas

# Bibliography

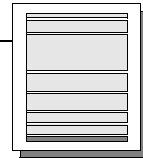

- [AC 91] Alpern B., Carter L.: 'Hyperbox', Proc. Visualization '91, San Diego, CA, 1991, pp. 133-139.
- [ADLP 95] Anupam V., Dar S., Leibfried T., Petajan E.: 'DataSpace: 3-D Visualization of Large Databases', Proc. Int. Symp. on Information Visualization, Atlanta, GA, 1995, pp. 82-88.
- [AKK 96] M. Ankerst, D. A. Keim, H.-P. Kriegel: 'Circle Segments: A Technique for Visually Exploring Large Multidimensional Data Sets', VISUALIZATION '96, HOT TOPIC SESSION, San Francisco, CA, 1996.
- [And 72] Andrews D. F.: 'Plots of High-Dimensional Data', in: Biometrics, Vol. 29, 1972, pp. 125-136.
- [And 95] Andrews K.: 'Visualizing Cyberspace: Information Visualization in the Harmony Internet Browser', Proc. Int. Symp. on Information Visualization, Atlanta, GA, 1995, pp. 97-104.
- [AS 94] Ahlberg C., Shneiderman B.: 'Visual Information Seeking: Tight Coupling of Dynamic Query Filters with Starfield Displays', Proc. Human Factors in Computing Systems CHI '94 Conf., Boston, MA, 1994, pp. 313-317.
- [AS 95] Ayers E. Z., Stasko J. T.: 'Using Graphic History in Browsing the World Wide Web', Proc. 4th Int. World Wide Web Conf., Boston, MA, 1995.
- [Asi 85] Asimov D.: 'The Grand Tour: A Tool For Viewing Multidimensional Data', SIAM Journal of Science & Stat. Comp., Vol. 6, 1985, pp. 128-143.
- [AW 95a] Ahlberg C., Wistrand E.: 'IVEE: An Environment for Automatic Creation of Dynamic Queries Applications', Proc. Human Factors in Computing Systems CHI '95 Conf., Demo Program, Denver, CO, 1995.
- [AW 95b] Ahlberg C., Wistrand E.: 'IVEE: An Information Visualization and Exploration Environment', Proc. Int. Symp. on Information Visualization, Atlanta, GA, 1995, pp. 66-73.

# Bibliography

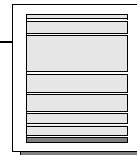

- [BCS 96] Becker R. A., Cleveland W. S., Shyu M.-J.: *'The Visual Design and Control of Trellis Display'*, Journal of Computational and Graphical Statistics, Vol. 5, No. 2, 1996, pp. 123-155.
- [BSC 96] Buja A., Swayne D. F., Cook D.: *'Interactive High-Dimensional Data Visualization'*, Journal of Computational and Graphical Statistics, Vol. 5, No. 1, 1996, pp. 78-99.
- [BCW 88] Becker R., Chambers J. M., Wilks A. R.: *'The New S Language'*, Wadsworth & Brooks/Cole Advanced Books and Software, Pacific Grove, CA, 1988.
- [BE 96] Ball T., Eick S.: *'Software Visualization in the Large'*, Computer, Vol. 29, No. 4, 1996, pp. 33-43.
- [Bed 90] Beddow J.: *'Shape Coding of Multidimensional Data on a Mircocomputer Display'*, Visualization '90, San Francisco, CA, 1990, pp. 238-246.
- [Bed 94] Bederson B.: *'Pad++: Advances in Multiscale Interfaces'*, Proc. Human Factors in Computing Systems CHI '94 Conf., Boston, MA, 1994, p. 315.
- [BEMW 90] Becker R. A., Eick S. G., Miller E. O., Wilks A. R.: *'Dynamic Graphics for Network Visualization'*, Proc. Visualization '90, San Francisco, CA, 1990, pp. 93-95.
- [Ben 95] Benford S., Snowdon D., Greenhaigh C., Ingram R., Knox I., Brown C.: *'Vr-vibe: A Virtual Environment for Co-operative Information Retrieval'*, Proc. Eurographics '95, Maastricht, The Netherlands, 1995, pp. 349-360.
- [Ber 81] Bertin J.: *'Graphics and Graphic Information Processing'*, Berlin, 1981.
- [BETT 94] Battista G. D., Eades P., Tamassia R., Tollis I.: *'Annotated Bibliography on Graph Drawing Algorithms'*, Computational Geometry: Theory and Applications, Vol. 4, 1994, pp. 235-282.

# Bibliography

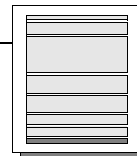

- [BEW 95] Becker R. A., Eick S. G., Wilks A. R.: *'Visualizing Network Data'*, Transactions on Visualization and Computer Graphics, Vol. 1, No. 1, 1995, pp. 16-28.
- [BF 93] Beshers C., Feiner S.: *'AutoVisual: Rule-Based Design of Interactive Multivariate Visualizations'*, IEEE Computer Graphics and Applications, Vol. 13, No. 4, 1993, pp. 41-49.
- [BFN 86] Boecker H.-D., Fischer G., Nieper H.: *'The Enhancement of Understanding through Visual Representations'*, Proc. Human Factors in Computing Systems CHI '86 Conf., Boston, MA, 1986, pp. 44-58.
- [BH 86] Bryce D., Hull R.: *'SNAP: A Graphics Based Schema Manager'*, Proc. 2nd Int. Conf. on Data Engineering, Los Angeles, CA, 1986, pp. 151-164.
- [BH 91] Brown M. H., Hershberger J.: *'Color and Sound in Algorithm Animation'*, Proc. IEEE Symp. on Visual Languages, 1991, pp. 10-17.
- [BH 94] Bederson B. B., Hollan J. D.: *'Pad++: A Zooming Graphical Interface for Exploring Alternate Interface Physics'*, Proc. UIST, 1994, pp. 17-26.
- [Bie 93] Bier E. A., Stone M. C., Pier K., Buxton W., DeRose T.: *'Toolglass and Magic Lenses: The see-through Interface'*, Proc. SIGGRAPH '93, Anaheim, CA, 1993, pp. 73-80.
- [BMMS 91] Buja A., McDonald J. A., Michalak J., Stuetzle W.: *'Interactive Data Visualization Using Focusing and Linking'*, Visualization '91, San Diego, CA, 1991, pp. 156-163.
- [BN 93] Brown M. H., Najork M. A.: *'Algorithm Animation Using 3D Interactive Graphics'*, Proc. UIST, 1993, pp. 93-100.

# Bibliography

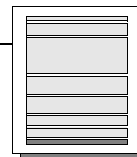

- [Bro 91] Brown M. H.: *'Zeus: A System for Algorithm Animation and Multi-View Editing'*, Proc. IEEE Symp. on Visual Languages, 1991, pp. 4-9.
- [Car 96] Card S. K.: *'Visualizing Retrieved Information: A Survey'*, IEEE CG&A, 1996, pp. 63-67.
- [CE 95] Cox K. C., Eick S. G.: *'3D Displays of Internet Traffic'*, Proc. Symp. on Information Visualization, Atlanta, GA, 1995, pp. 129-131.
- [CELR 94] Cohen R. F., Eades P., Lin T., Ruskey F.: *'Three-dimensional Graph Drawing'*, Proc. Graph Drawing, 1994, in: Lecture Notes in Computer Science, Vol. 894, Springer, 1994, pp. 1-11.
- [Che 73] Chernoff H.: *'The Use of Faces to Represent Points in k-Dimensional Space Graphically'*, Journal Amer. Statistical Association, Vol. 68, pp. 361-368.
- [CK 95] Carrière J., Kazman R.: *'Interacting with Huge Hierarchies: Beyond Cone Trees'*, Proc. Symp. on Information Visualization, Atlanta, GA, 1995, pp. 90-96.
- [Cle 93] Cleveland W. S.: *'Visualizing Data'*, AT&T Bell Laboratories, Murray Hill, NJ, Hobart Press, Summit NJ, 1993.
- [Cle 94] Cleveland W. S.: *'The Elements of Graphing Data'*, Hobart Press, Summit, NJ, revised edition.
- [CM 93] Consens M. P., Mendelzon A. O.: *'Hy+: A Hygraph-based Query and Visualization System'*, Proc. ACM SIGMOD Int. Conf. on Management of Data, Washington, DC, 1993, pp. 511-516.
- [Con 94] Consens M. P., Eigler F. Ch., Hasan M. Z., Mendelzon A. O., Noik E. G., Ryman A. G., Vista D.: *'Architecture and Applications of the Hy+ Visualization System'*, IBM Systems Journal, Vol. 33, No. 3, 1994, pp. 458-476.

# Bibliography

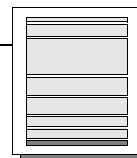

- [CPS 95] Chan M. C., Pacifici G., Stadler R.: *'Managing Real-Time Services in Multimedia Networks Using Dynamic Visualization and high-level Controls'*, Proc. Multimedia '95, San Francisco, CA, 1995.
- [CR 92] Cox K. C., Roman G.-C.: *'Abstraction in Algorithm Animation'*, Proc. Symp. on Visual Languages, 1992, pp. 18-23.
- [CRMK 95] Chuah M. C., Roth S. F., Mattis J., Kolojejchick J.: *'SDM: Malleable Information Graphics'*, Proc. Symp. on Information Visualization '95, Atlanta, GA, 1995, pp. 36-42.
- [CRY 96] Card S. K., Robertson G. G., York W.: *'The WebBook and the WebForager: An Information Workspace for the World Wide Web'*, Proc. Human Factors in Computing Systems CHI '96 Conf., 1996.
- [CT 94] Cruz I. F., Tamassia R.: *'How to Visualize a Graph: Specification and Algorithms'*, 1994.
- [DE 82] Dunn G., Everitt B.: *'An Introduction to Mathematical Taxonomy'*, Cambridge University Press, Cambridge, MA, 1982.
- [DH 95] Drew N. S., Hendley R. J.: *'Visualizing Complex Interacting Systems'*, Proc. Human Factors in Computing Systems CHI'95 Conf., Denver, CO, 1995, pp. 204-205.
- [Doe 94] Doemel P.: *'Webmap - A Graphical Hypertext Navigation Tool'*, Proc. 2nd Int. World Wide Web Conf., Chicago, IL, 1994.
- [Eic 94] Eick S. G.: *'Data Visualization Sliders'*, Proc. ACM UIST, 1994, pp. 119-120.
- [Eic 96] Eick S. G.: *'Aspects of Network Visualization'*, Proc. IEEE CG&A, 1996, pp. 69-72.

# Bibliography

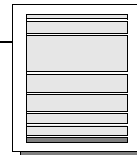

- [ES 92] Eick S. G., Steffen J. L.: '*Visualizing Code Profiling Line Oriented Statistics*', Proc. Visualization '92, Boston, MA, 1992, pp. 210-217.
- [ESS 92] Eick S. G., Steffen J. L., Sumner E. E.: '*SeeSoft - A Tool for Visualizing Software*', IEEE Transactions on Software Engineering, Vol. 18, No. 11, 1992, pp. 957-968.
- [EW 93] Eick S. G., Wills G. J.: '*Navigating Large Networks with Hierarchies*', Visualization '93, San Jose, CA, 1993, pp. 204-210.
- [FB 90a] Feiner S., Beshers C.: '*Visualizing n-Dimensional Virtual Worlds with n-Vision*', Computer Graphics, Vol. 24, No. 2, 1990, pp. 37-38.
- [FB 90b] Feiner S., Beshers C.: '*World within World: Metaphors for Exploring n-dimensional Virtual Worlds*', Proc. UIST, 1990, pp. 76-83.
- [FB 94] Furnas G. W., Buja A.: '*Prosections Views: Dimensional Inference through Sections and Projections*', Journal of Computational and Graphical Statistics, Vol. 3, No. 4, 1994, pp. 323-353.
- [FB 95] Furnas G. W., Bederson B. B.: '*Space-Scale Diagrams: Understanding Multiscale Interfaces*', Proc. Human Factors in Computing Systems CHI '95 Conf., Denver, CO, 1995.
- [FL 95] Faloutsos C., Lin K.: '*Fastmap: A fast Algorithm for Indexing, Data-Mining and Visualization of Traditional and Multimedia Datasets*', Proc. ACM SIGMOD Int. Conf. on Management of Data, San Jose, CA, 1995, pp. 163-174.
- [FPF 88] Fairchild K., Poltrok S., Furnas G.: '*SemNet: Three Dimensional Graphic Representations of Large Knowledge Bases*', Lawrence Erlbaum (ed.), 1988, pp. 201-233.

# Bibliography

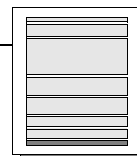

- [FS 95] Fishkin K., Stone M. C.: '*Enhanced Dynamic Queries via Movable Filters*', Proc. Human Factors in Computing Systems CHI '95 Conf., Denver, CO, 1995, pp. 415-420.
- [Fur 86] Furnas G.: '*Generalized Fisheye Views*', Proc. Human Factors in Computing Systems CHI '86 Conf., Boston, MA, 1986, pp. 18-23.
- [FW 94] Frolich M., Werner M.: '*Demonstration of the Interactive Graph Visualization System da vinci*', Proc. Graph Drawing, 1994, in: Lecture Notes in Computer Science, Vol. 894, Springer, 1994, pp. 266-269.
- [FZ 94] Furnas G. W., Zacks J.: '*Multitrees: Enriching and Reusing Hierarchical Structures*', Proc. Human Factors in Computing Systems CHI '94 Conf., Boston, MA, 1994, pp. 330-336.
- [Ger 95] Gershon N., LeVasseur J., Winstead J., Croall J., Pernick A., Ruh W.: '*Visualizing Internet Resources*', Proc. Symp on Information Visualization '95, Atlanta, GA, 1995, pp. 122-128.
- [Ger 96] Gershon N.: '*Moving Happily Through the World Wide Web*', Proc. IEEE CG&A, 1996, pp. 72-74.
- [GKNV 93] Gansner E. R., Koutsofois E., North S. C., Vo K.-P.: '*A Technique for Drawing Directed Graphs*', IEEE Transactions on Software Engineering, Vol. 19, No. 3, 1993, pp. 214-229.
- [GPW 89] Grinstein G., Pickett R., Williams M. G.: '*EXVIS: An Exploratory Visualization Environment*', Proc. Graphics Interface '89, London, Ontario, Canada, 1989.
- [GR 94] Goldstein J., Roth S. F.: '*Using Aggregation and Dynamic Queries for Exploring Large Data Sets*', Proc. Human Factors in Computing Systems CHI '94 Conf., Boston, MA, 1994, pp. 23-29.



# Bibliography

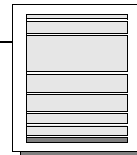

- [GT 96] Garg A., Tamassia R.: 'Giotto3d: A System for Visualizing Hierarchical Structures in 3d', Proc. Graph Drawing '96, in: Lecture Notes in Computer Science, Springer, 1996.
- [Har 67] Harman H. H.: 'Modern Factor Analysis', University of Chicago Press, 1967.
- [HC 86] J.D.A. Henderson and S.K. Card: 'Rooms: The Use of Multiple Virtual Workspaces to Reduce Space Contention in Window-based Graphical User Interfaces', ACM Trans. on Graphics, Vol. 5, No. 3, July 1986, pp. 211-241.
- [HDWB 95] Hendley R. J., Drew N. S., Wood A. M., Beale R.: 'Narcissus: Visualizing Information', Proc. Int. Symp. on Information Visualization, Atlanta, GA, 1995, pp. 90-94.
- [Hea 95] Hearst M.: 'TileBars: Visualization of Term Distribution Information in Full Text Information Access', Proc. of ACM Human Factors in Computing Systems Conf. (CHI'95), 1995, pp. 59-66.
- [Him 94] Himsolt M.: 'Graphed: A Graphical Platform for the Implementation of Graph Algorithms', Proc. Graph Drawing '94, in: Lecture Notes in Computer Science, Vol. 894, Springer, pp. 182-193.
- [Hub 85] Huber P. J.: 'Projection Pursuit', The Annals of Statistics, Vol. 13, No. 2, 1985, pp. 435-474.
- [Ins 85] Inselberg A.: 'The Plane with Parallel Coordinates, Special Issue on Computational Geometry', The Visual Computer, Vol. 1, 1985, pp. 69-97.
- [ID 90] Inselberg A., Dimsdale B.: 'Parallel Coordinates: A Tool for Visualizing Multi-Dimensional Geometry', Visualization '90, San Francisco, CA, 1990, pp. 361-370.
- [JJ 94] Jeron T., Jard C.: '3D Layout of Reachability Graphics of Communicating Processes', Proc. Graph Drawing '94, in: Lecture Notes in Computer Science, Vol. 894, 1994, pp. 25-32.

# Bibliography

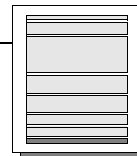

- [Joh 93] Johnson B.: 'Visualizing Hierarchical and Categorical Data', Ph.D. Thesis, Department of Computer Science, University of Maryland, 1993.
- [JS 91] Johnson B., Shneiderman B.: 'Treemaps: A Space-filling Approach to the Visualization of Hierarchical Information', Proc. Visualization '91 Conf., 1991, pp. 284-291.
- [JS 95] Jerding D. F., Stasko J. T.: 'The Information Mural: A Technique for Displaying and Navigating Large Information Spaces', Proc. Symp. on Information Visualization '95, Atlanta, GA, 1995, pp. 43-50.
- [Kei 95] D. A. Keim: 'Enhancing the Visual Clustering of Query-dependent Database Visualization Techniques using Screen-Filling Curves', PROC. WORKSHOP ON DATABASE ISSUES FOR DATA VISUALIZATION, Atlanta, GA, 1995, Springer, in: Lecture Notes in Computer Science, No. 1183, Springer, pp. 101-110.
- [Kei 96] Keim D. A.: 'Pixel-oriented Visualization Techniques for Exploring Very Large Databases', Journal of Computational and Graphical Statistics, Vol. 5, No. 1, 1996, pp. 58-77.
- [KK 94] Keim D. A., Kriegel H.-P.: 'VisDB: Database Exploration using Multidimensional Visualization', Computer Graphics & Applications, Sept. 1994, pp. 40-49.
- [KK 95] Keim D. A., Kriegel H.-P.: 'VisDB: A System for Visualizing Large Databases', System Demonstration, Proc. ACM SIGMOD Int. Conf. on Management of Data, San Jose, CA, 1995, p. 482.
- [KKA 95] Keim D. A., Kriegel H.-P., Ankerst M.: 'Recursive Pattern: A Technique for Visualizing Very Large Amounts of Data', Proc. Visualization '95, Atlanta, GA, 1995, pp. 279-286.

# Bibliography

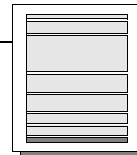

- [KKS 94] Keim D. A., Kriegel H.-P., Seidl T.: *'Supporting Data Mining of Large Databases by Visual Feedback Queries'*, Proc. 10th Int. Conf. on Data Engineering, Houston, TX, 1994, pp. 302-313.
- [KK 96] Keim D. A., Kriegel H.-P.: *'Visualization Techniques for Mining Large Databases: A Comparison'*, Transactions on Knowledge and Data Engineering, Vol. 8, No. 6, Dec. 1996, pp. 923-938.
- [KL 93] Keim D. A., Lum V.: *'GRADI: A Graphical Database Interface for a Multimedia DBMS'*, Proc. Int. Workshop on Interfaces to Databases, Glasgow, England, 1992, in: Workshops in Computing, Springer, 1993, pp. 95-112.
- [KRB 94] Kaugars K., Reinfelds J., Brazma A.: *'A Simple Algorithm for Drawing Large Graphs on Small Screens'*, Proc. Graph Drawing '94, in: Lecture Notes in Computer Science, Vol. 894, Springer, 1994, pp. 278-281.
- [LA 94] Leung Y., Apperley M.: *'A Review and Taxonomy of Distortion-oriented Presentation Techniques'*, Proc. Human Factors in Computing Systems CHI '94 Conf., Boston, MA, 1994, pp. 126-160.
- [Lev 91] Levkowitz H.: *'Color icons: Merging color and texture perception for integrated visualization of multiple parameters'*, In Visualization '91, San Diego, CA, October 22-25 1991.
- [Liv 97] Miron Livny, Raghu Ramakrishnan, Kevin Beyer, Guangshun Chen, Donko Donjerkovic, Shilpa Lawande, Jussi Myllymaki, and Kent Wenger: *'DEVise: Integrated Querying and Visual Exploration of Large Datasets'*, Proc. of ACM SIGMOD, May, 1997.
- [LR 94] Lamping J., Rao R.: *'Laying out and Visualizing Large Trees Using a Hyperbolic Space'*, Proc. UIST, 1994, pp. 13-14.

# Bibliography

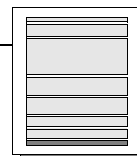

- [LRP 95] Lamping J., Rao R., Pirolli P.: *'A Focus + Context Technique Based on Hyperbolic Geometry for Visualizing Large Hierarchies'*, Proc. Human Factors in Computing Systems CHI '95 Conf., Denver, CO, 1995, pp. 401-408.
- [LSR 96] Lamm S. E., Scullin W. H., Reed D. A.: *'Real-time Geographic Visualization of World Wide Web Traffic'*, Proc. WWW, 1996.
- [LWW 90] LeBlanc J., Ward M. O., Wittels N.: *'Exploring N-Dimensional Databases'*, Visualization '90, San Francisco, CA, 1990, pp. 230-239.
- [MB 95] Munzner T., Burchard P.: *'Visualizing the Structure of the World Wide Web in 3D Hyperbolic Space'*, Proc. VRML '95 Symp, San Diego, CA, 1995, pp. 33-38.
- [MF 95] Mukherjea S., Foley J. D.: *'Showing the Context of Nodes in the World-Wide Web'*, Proc. ACM SIGCHI, Denver, CO, 1995.
- [MF 95] Mukherjea S., Foley J. D.: *'Visualizing Complex Hypermedia Networks through Multiple Hierarchical Views'*, Proc. ACM SIGCHI, Denver, CO, 1995.
- [MF 95] Mukherjea S., Foley J. D.: *'Visualizing the World-Wide Web with the Navigational View Builder'*, Proc. 3rd Int. World Wide Web Conf., Darmstadt, Germany, 1995.
- [MGTS 90] Mihalisin T., Gawlinski E., Timlin J., Schwendler J.: *'Visualizing A Scalar Field on an N-dimensional Lattice'*, Visualization '90, San Francisco, CA, 1990, pp. 255-262.
- [MHCF 96] Munzner T., Hoffman E., Claffy K., Fenner B.: *'Visualizing the Global Topology of the mbone'*, Proc. Symp. on Information Visualization, 1996.

# Bibliography

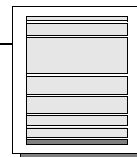

- [MMIK 95] Masui T., Minakuchi M., IV G. R., Kashiwagi K.: *'Multiple-View Approach for Smooth Information Retrieval'*, Proc. UIST, 1995, pp. 199-206.
- [MRC 91] Mackinlay J. D., Robertson G. G., Card S. K.: *'The Perspective Wall: Detail and Context Smoothly Integrated'*, Proc. Human Factors in Computing Systems CHI '91 Conf., New Orleans, LA, 1991, pp. 173-179.
- [MSG 94] McCreary C., Shieh F.-S., Gill H.: *'Cg: A Graph Drawing System Using Graph-Grammar Parsing'*, Proc. Graph Drawing '94, in: Lecture Notes in Computer Science, Vol. 894, Springer, 1994, pp. 270-273.
- [MW 95] Martin A. R., Ward M. O.: *'High Dimensional Brushing for Interactive Exploration of Multivariate Data'*, Visualization '95, Atlanta, GA, 1995, pp. 271-278.
- [Mye 94] Myers B. A.: *'Visual Programming, Programming by Example and Program Visualization: A Taxonomy'*, Proc. Human Factors in Computing Systems CHI '94 Conf., Boston, MA, 1994, pp. 59-66.
- [NK 94] North S. C., Koutsofois E.: *'Applications of Graph Visualization'*, Proc. Graphics Interface, 1994, pp. 235-245.
- [Noi 93] Noik E. G.: *'Layout-independent Fisheye Views of Nested Graphs'*, Proc. Symp. on Visual Languages, 1993, pp. 336-341.
- [Noi 94] Noik E. G.: *'Encoding Presentation Emphasis Algorithms for Graphs'*, Proc. Graph Drawing '94, in: Lecture Notes in Computer Science, Vol. 894, Springer, 1994, pp. 428-235.
- [Noi 94] Noik E. G.: *'A Space of Presentation Emphasis Techniques for Visualizing Graphs'*, Proc. Graphics Interface, 1994, pp. 225-233.

# Bibliography

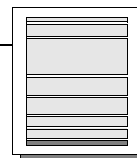

- [Ols 93] Olsen K.A. et al.: *'Visualization of a Document Collection: The VIBE System'*, Information Processing and Management, Vol. 29, No. 1, 1993, pp. 69-81.
- [OW 93] Ozoyoglu G., Wang H.: *'Example-Based Graphical Database Query Languages'*, Computer, Vol. 26, No. 5, 1993, pp. 25-38.
- [PB 94] Pitkow J., Bharat K.: *'Webviz: A Tool for World-Wide Web Access Log Visualization'*, Proc. 1st Int. World Wide Web Conf., Geneva, Switzerland, 1994.
- [PF 93] Perlin K., Fox D.: *'Pad: An Alternative Approach to the Computer Interface'*, Proc. SIGGRAPH, Anaheim, CA, 1993, pp. 57-64.
- [PG 88] Pickett R. M., Grinstein G. G.: *'Iconographic Displays for Visualizing Multidimensional Data'*, Proc. IEEE Conf. on Systems, Man and Cybernetics, IEEE Press, Piscataway, NJ, 1988, pp. 514-519.
- [Pic 70] Pickett R. M.: *'Visual Analyses of Texture in the Detection and Recognition of Objects'*, in: Picture Processing and Psycho-Pictorics, Lipkin B. S., Rosenfeld A. (eds.), Academic Press, New York, 1970.
- [Rao 92] Rao R., Card S. K., Jellinek H. D., Mackinlay J. D., Robertson G. G.: *'The Information Grid: A Framework for Information Retrieval and Retrieval-centered Applications'*, Proc. UIST, 1992, pp. 23-32.
- [RC 94] Rao R., Card S. K.: *'The Table Lens: Merging Graphical and Symbolic Representation in an Interactive Focus+Context Visualization for Tabular Information'*, Proc. Human Factors in Computing Systems CHI '94 Conf., Boston, MA, 1994, pp. 318-322.

# Bibliography

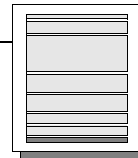

- [RCM 93] Robertson G. G., Card S. K., Mackinlay J. D.: '*Information Visualization Using 3D Interactive Animation*', Communications of the ACM, Vol. 36, No. 4, 1993, pp. 57-71.
- [Reg 93] Regan B.: '*Two Algorithms for Drawing Trees in Three Dimensions*', Proc. Graph Drawing, 1993.
- [Rei 93] Reiss S. P.: '*A Framework for Abstract 3D Visualization*', Proc. Symp. on Visual Languages, 1993, pp. 108-115.
- [Rei 94] Reiss S. P.: '*3-D Visualization of Program Information*', Proc. Graph Drawing, 1994, in: Lecture Notes in Computer Science, Vol. 894, Springer, 1994, pp. 12-24.
- [Ren 94] Rennison E.: '*Galaxy of News: An Approach to Visualizing and Understanding Expansive News Landscapes*', Proc. UIST, 1994, pp. 3-12.
- [RG 93] Rekimoto J., Green M.: '*The Information Cube: Using Transparency in 3d Information Visualization*', Proc. 3rd Annual Workshop on Information Technologies & Systems (WITS '93), 1993, pp. 125-132.
- [RM 93] Robertson G. G., Mackinlay J. D.: '*The Document Lens*', Proc. UIST, 1993, pp. 101-108.
- [RMC 91] Robertson G. G., Mackinlay J. D., Card S. K.: '*Cone Trees: Animated 3D Visualizations of Hierarchical Information*', Proc. Human Factors in Computing Systems CHI '91 Conf., New Orleans, LA, 1991, pp. 189-194.
- [SA 82] Spence R., Apperley M.: '*Data Base Navigation: An Office Environment for the Professional*', Behaviour and Information Technology, Vol. 1, No. 1, pp. 43-54.
- [San 94] Sander G.: '*Graph Layout through the VCG Tool*', Proc. Graph Drawing, 1994, in: Lecture Notes in Computer Science, Springer, Vol. 894, Springer, 1994, pp. 194-205.

# Bibliography

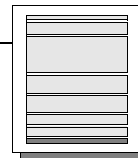

- [SB 94] Sarkar M., Brown M.: '*Graphical Fisheye Views*', Communications of the ACM, Vol. 37, No. 12, 1994, pp. 73-84.
- [SCB 92] Swayne D. F., Cook D., Buja A.: '*User's Manual for XGobi: A Dynamic Graphics Program for Data Analysis*', Bellcore Technical Memorandum, 1992.
- [Sch 93] Schaffer, Doug, Zuo, Zhengping, Bartram, Lyn, Dill, John, Dubs, Shelli, Greenberg, Saul, Roseman, Mark: '*Comparing Fisheye and Full-Zoom Techniques for Navigation of Hierarchically Clustered Networks*', Proc. Graphics Interface (GI '93), Toronto, Ontario, 1993, in: Canadian Information Processing Soc., Toronto, Ontario, Graphics Press, Cheshire, CT, 1993, pp. 87-96.
- [SDTS 95] Su H., Dawkes H., Tweedie L., Spence R.: '*An Interactive Visualization Tool for Tolerance Design*', Technical Report, Imperial College, London, 1995.
- [SFB 94] Stone M. C., Fishkin K., Bier E. A.: '*The Movable Filter as a User Interface Tool*', Proc. Human Factors in Computing Systems CHI '94 Conf., Boston, MA, 1994, pp. 306-312.
- [Shn 92] Shneiderman B.: '*Tree Visualization with Treemaps: A 2D Space-Filling Approach*', ACM Transactions on Graphics, Vol. 11, No. 1, pp. 92-99, 1992.
- [SM 94] Sugiyama K., Misue K.: '*A Simple and Unified Method for Drawing Graphs: Magnetic-spring Algorithm*', Proc. Graph Drawing, 1994, in: Lecture Notes in Computer Science, Vol. 894, Springer, 1994, pp. 364-375.
- [SP 92] Stasko, John T. and Patterson, Charles, "Understanding and Characterizing Software Visualization Systems", Proc. of the 1992 IEEE Workshop on Visual Languages, Seattle, WA, September 1992, pp. 3-10.

# Bibliography

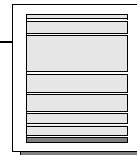

- [Spo 93] Spoerri A.: *'InfoCrystal: A Visual Tool for Information Retrieval'*, Visualization '93, San Jose, CA, 1993, pp. 150-157.
- [STDS 95] Spence R., Tweedie L., Dawkes H., Su H.: *'Visualization for Functional Design'*, Proc. Int. Symp. on Information Visualization (InfoVis '95), Atlanta, GA, 1995, pp.4-10.
- [SRN 72] Shepard R. N., Romney A. K., Nerlove S. B.: *'Multidimensional Scaling'*, Seminar Press, New York, 1972.
- [SW 93] Stasko J. T., Wehrli J. F.: *'Three-dimensional Computation Visualization'*, Proc. Symp. on Visual Languages, Bergen, Norway, 1993, pp. 100-107.
- [TD 95] Tal A., Dobkin D.: *'Visualization of Geometric Algorithms'*, Transactions on Visualization and Computer Graphics, Vol. 1, No. 2, 1995, pp. 194-204.
- [Tuf 83] Tufte E. R.: *'The Visual Display of Quantitative Information'*, Graphics Press, Cheshire, CT, 1983.
- [Tuf 90] Tufte E. R.: *'Envisioning Information'*, Graphics Press, Cheshire, CT, 1990.
- [Vas 94] Vasudevan V.: *'Supporting High Bandwidth Navigation in Object-Bases'*, Proc. 10th Int. Conf. on Data Engineering, Houston, TX, 1994, pp. 294-301.
- [Vel 92] Velleman P. F.: *'Data Desk 4.2: Data Description'*, Ithaca, NY, 1992.
- [War 94] Ward M. O.: *'XmdvTool: Integrating Multiple Methods for Visualizing Multivariate Data'*, Visualization'94, Washington, DC, 1994, pp. 326-336.

# Bibliography

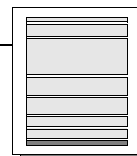

- [Wis 95] Wise J. A., Thomas J. J., Pennock K., Lantrip D., Pottier M., Schur A., Crow V.: *'Visualizing the Non-Visual: Spatial Analysis and Interaction with Information from Text Documents'*, Proc. Symp. on Information Visualization, Atlanta, GA, 1995, pp. 51-58.
- [WB 95] Wong P.C., Bergeron R. D.: *'30 Years of Multidimensional Multivariate Visualization'*, Proc. Workshop on Scientific Visualization, IEEE Computer Society Press, 1995.
- [WDBH 95] Wood A., Drew N., Beale R., Hendley B.: *'Hyperspace: Web Browsing with Visualisation'*, Proc. 3rd Int. World-Wide Web Conf., Poster, 1995, Darmstadt, Germany.
- [WL 93] van Wijk J. J., van Liere R., D.: *'Hyperslice'*, Proc. Visualization '93, San Jose, CA, 1993, pp. 119-125.
- [Wri 95] Wright W.: *'Information Animation Applications in the Capital Markets'*, Proc. Int. Symp. on Information Visualization, Atlanta, GA, 1995, pp. 19-25.
- [WUT 95] Wilhelm A., Unwin A.R., Theus M.: *'Software for Interactive Statistical Graphics - A Review'*, Proc. Int. Softstat '95 Conf., Heidelberg, Germany, 1995.
- [XGobi] XGobi Web-Page including pointers to publications and the most recent release of the XGobi software: "<http://www.research.att.com/~andreas/xgobi/>".
- [YS 93] Young D. and Shneiderman B.: *'A graphical filter/flow model for boolean queries: An implementation and experiment'*, Journal of the American Society for Information Science Vol. 44, No. 6, 1993, pp. 327-339.
- [Zlo 77] Zloof M. M.: *'Query-By-Example: A Data Base Language'*, IBM Systems Journal, Vol. 4, 1977, pp. 324-343.